



Data Center System Selection Guide

For use in Europe, Middle East and Africa

COMMScope[®]
an Amphenol company





INTRODUCTION

Data centers: Evolutionary change, revolutionary opportunities

The data center's role in our everyday lives continues to grow and evolve at a dizzying pace. Hyperscale, enterprise, service provider and multi-tenant data centers are driving the new business models of today and unlocking the potential of powerful new applications—such as AI—to shape the world of tomorrow.

Fast evolution requires nimble thinking and innovative technology to direct these new capabilities along the most efficient path to meet the exploding demand—and to capture an optimal share of the billions of dollars in revenue realized by data center operations every year. For decades, CommScope has been a global leader in providing the infrastructure solutions that empower this evolution.

The infrastructure that drives the future

CommScope's innovative portfolios of carrier-grade fiber and copper connectivity and management solutions help data centers manage and meet exponentially-growing demand. From entrance facilities and cross-connects to the meet-me rooms and customer cages, CommScope supports the fiber-dense applications and migration agility that drive the data center business model.

We deliver innovative solutions that address all the priorities of a modern data center, not only performance, but efficiency, profitability and sustainability as well. Speed matters, too—so with CommScope's global manufacturing network and CommScope Express expedited delivery service, the world's most advanced fiber and copper connectivity solutions are never more than a week away.

End-to-end connectivity solutions

CommScope's data center solutions span virtually every cable, connector and enclosure, supporting the most critical functions of the data center. Our powered fiber cabling solution remotely connects and powers a wide range of IP devices, nodes and sensors, while the FiberGuide® optical raceway solution connects, manages, distributes and protects your fiber plant across all areas of the data center. And these are only the beginning.

Empower your data center's evolution with innovative infrastructure solutions from CommScope. Regardless of size, configuration or purpose, your data center can run with greater agility, reliability and efficiency with CommScope's data center infrastructure solutions.

It all begins here

Whatever your needs, this guide will provide a CommScope solution that has anticipated it. Read on to see how your data center's evolution can become revolutionary—with CommScope.



Direct System Selection

Fiber Splice Systems	4
Splice Closures	5
TENIO	5
FIST-MSC	5
Building Entrance Solutions	7
IFEB	8
FACT-WR	9
FACT Splice Frame	10
FACT Optical Distribution Frame (ODF)	11
Propel XFrame	18
19" Splice Solutions	20
Singlemode Fiber Cables	23
Pre-terminated Fiber Systems	28
Pre-terminated 19" Fiber System Solutions	29
Pre-terminated FACT ODF Fiber System Solutions	36
Fiber Optic Patch Cords	38
FiberGuide® Raceway Systems	43
Category 6A Systems	47
Cable Management & Overhead Racks	49
FiberREACH Platform	51

Architecture System Selection

Colocation Campus and Building Infrastructure	54
Fiber Entrance and Meet-Me Room	56
High Fiber Count DC Interconnect	57
Campus Cabling	58
Building Cabling	59
Campus Cabling for Wi-Fi and Security	62
Customer Space Cabling Infrastructure	63
Main Distribution Area (MDA) Fiber	65
Equipment Distribution Area (EDA) Fiber	66
Equipment Distribution Area (EDA) Copper	67
FiberGuide Raceway Systems	68
Reference Designs and Technical Information	69
MDA Cabinet	70
MDA Cross-connect 19"	71
MDA Cross-connect FACT ODF	72
IDF FACT	73
IDF 19"	74



Fiber Splice Systems

Splice Closures

- TENIO

- FIST-MSD

Building Entrance Solutions

- IFEB

- FACT-WR

- FACT Splice Frame

- FACT Optical Distribution Frame (ODF)

- Propel XFrame

- 19" Splice Solutions

- Singlemode Fiber Cables



TENIO and FIST-MSD Splice Closures

CommScope's fiber closure family offers easy deployment and long-lasting solutions. Whether you're building an outside plant FTTx network or upgrading existing infrastructure, our closures deliver:

- **Reliability:** Our closures withstand environmental challenges, ensuring uninterrupted service.
- **Installability:** Quick and efficient installation saves time and resources.
- **Flexibility:** Adapt to changing network demands with ease.
- **Gel Sealing Technology:** CommScope's revolutionary gel sealing technology provides superior protection against moisture and environmental factors.

With over 30 years of experience, CommScope remains at the forefront of advanced network solutions. Trust us to help your network reach its full potential today and in the future.



Direct System Selection Index

Splice Closures	Building Entrance Solutions	FACT Optical Distribution Frame	Propel XFrame	19" Splice Solutions	Singlemode Fiber Cables	Pre-term 19" Fiber	Pre-term FACT ODF Fiber	Fiber Optic Patch Cords	FiberGuide	Copper Category 6A	Cable Management & Overhead Racks	FiberREACH
-----------------	-----------------------------	---------------------------------	---------------	----------------------	-------------------------	--------------------	-------------------------	-------------------------	------------	--------------------	-----------------------------------	------------

Architecture System Selection Index

Colocation Campus and Building Infrastructure

Fiber Entrance, Meet-Me Room	High Fiber Count DC Interconnect	Campus Cabling	Building Cabling	Campus Cabling for Wi-Fi and Security
------------------------------	----------------------------------	----------------	------------------	---------------------------------------

Customer Space Cabling Infrastructure

Overview	MDA Fiber	ToR Fiber	EoR Copper	FiberGuide Raceway
----------	-----------	-----------	------------	--------------------

Reference Designs and Technical Information

MDA Cabinet	MDA Cross-connect 19"	MDA Cross-connect FACT ODF	IDF FACT	IDF 19"
-------------	-----------------------	----------------------------	----------	---------



Please select your splice closure according the number of splices required

TENIO Fiber Closure

[Click to get to the Ordering Guide](#)

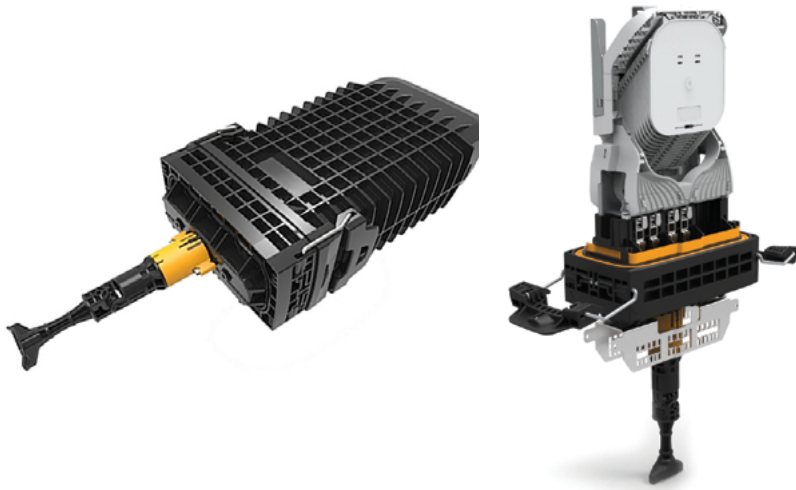

For a fiber count
up to 288

FIST MSC Closure

[Click to get to the Ordering Guide](#)



For a fiber count
from 432 to 1440

Direct System Selection Index

Splice Closures	Building Entrance Solutions	FACT Optical Distribution Frame	Propel XFrame	19" Splice Solutions	Singlemode Fiber Cables	Pre-term 19" Fiber	Pre-term FACT ODF Fiber	Fiber Optic Patch Cords	FiberGuide	Copper Category 6A	Cable Management & Overhead Racks	FiberREACH
-----------------	-----------------------------	---------------------------------	---------------	----------------------	-------------------------	--------------------	-------------------------	-------------------------	------------	--------------------	-----------------------------------	------------

Architecture System Selection Index

Colocation Campus and Building Infrastructure

Fiber Entrance, Meet-Me Room	High Fiber Count DC Interconnect	Campus Cabling	Building Cabling	Campus Cabling for Wi-Fi and Security
------------------------------	----------------------------------	----------------	------------------	---------------------------------------

Customer Space Cabling Infrastructure

Overview	MDA Fiber	ToR Fiber	EoR Copper	FiberGuide Raceway
----------	-----------	-----------	------------	--------------------

Reference Designs and Technical Information

MDA Cabinet	MDA Cross-connect 19"	MDA Cross-connect FACT ODF	IDF FACT	IDF 19"
-------------	-----------------------	----------------------------	----------	---------



Building entrance solution to convert outdoor fiber cables to indoor fiber cables

Select a product for more informaton

IFEB



12f - 528f



Internal Pathway



Indoor or Indoor/Outdoor Fiber Cable

FACT-WR



432f - 4032f

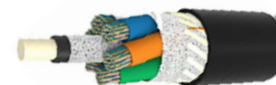

Outdoor Fiber Cable

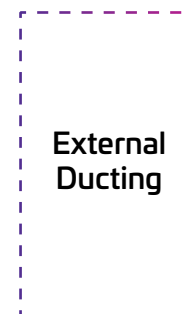

External Ducting

FACT Splice Frame

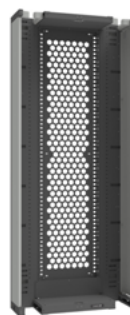

2016f - 8640f

Direct System Selection Index

Splice Closures	Building Entrance Solutions	FACT Optical Distribution Frame	Propel XFrame	19" Splice Solutions	Singlemode Fiber Cables	Pre-term 19" Fiber	Pre-term FACT ODF Fiber	Fiber Optic Patch Cords	FiberGuide	Copper Category 6A	Cable Management & Overhead Racks	FiberREACH
-----------------	-----------------------------	---------------------------------	---------------	----------------------	-------------------------	--------------------	-------------------------	-------------------------	------------	--------------------	-----------------------------------	------------

Architecture System Selection Index

Colocation Campus and Building Infrastructure

Fiber Entrance, Meet-Me Room	High Fiber Count DC Interconnect	Campus Cabling	Building Cabling	Campus Cabling for Wi-Fi and Security
------------------------------	----------------------------------	----------------	------------------	---------------------------------------

Customer Space Cabling Infrastructure

Overview	MDA Fiber	ToR Fiber	EoR Copper	FiberGuide Raceway
----------	-----------	-----------	------------	--------------------

Reference Designs and Technical Information

MDA Cabinet	MDA Cross-connect 19"	MDA Cross-connect FACT ODF	IDF FACT	IDF 19"
-------------	-----------------------	----------------------------	----------	---------



IFEB Building Entrance Splice

The CommScope family of Indoor Fiber Entry Box™ (IFEB) solutions provides data centers a broad and customizable portfolio that meets the size, capacity and functional requirements for most data center entrance facilities. The IFEB product family consists of five different wall-mounted, indoor fiber connection boxes, each available in three different layouts.

All IFEB solutions are built on a common framework, giving installation crews a familiar and repeatable platform for nearly all building entrance deployments. Leveraging next-generation fiber tray designs, the IFEB family meets or exceeds the most recent industry standards for fiber management. Sealing and cable fixation are optimized for indoor use, enabling operators to support higher-density, higher-capacity applications with a smaller-sized solution. This reduces space requirements for installation, cost per connection and the carbon footprint per connection. Eco-friendly multi-pack packaging, available with smaller IFEB boxes, helps further lower environmental impact.

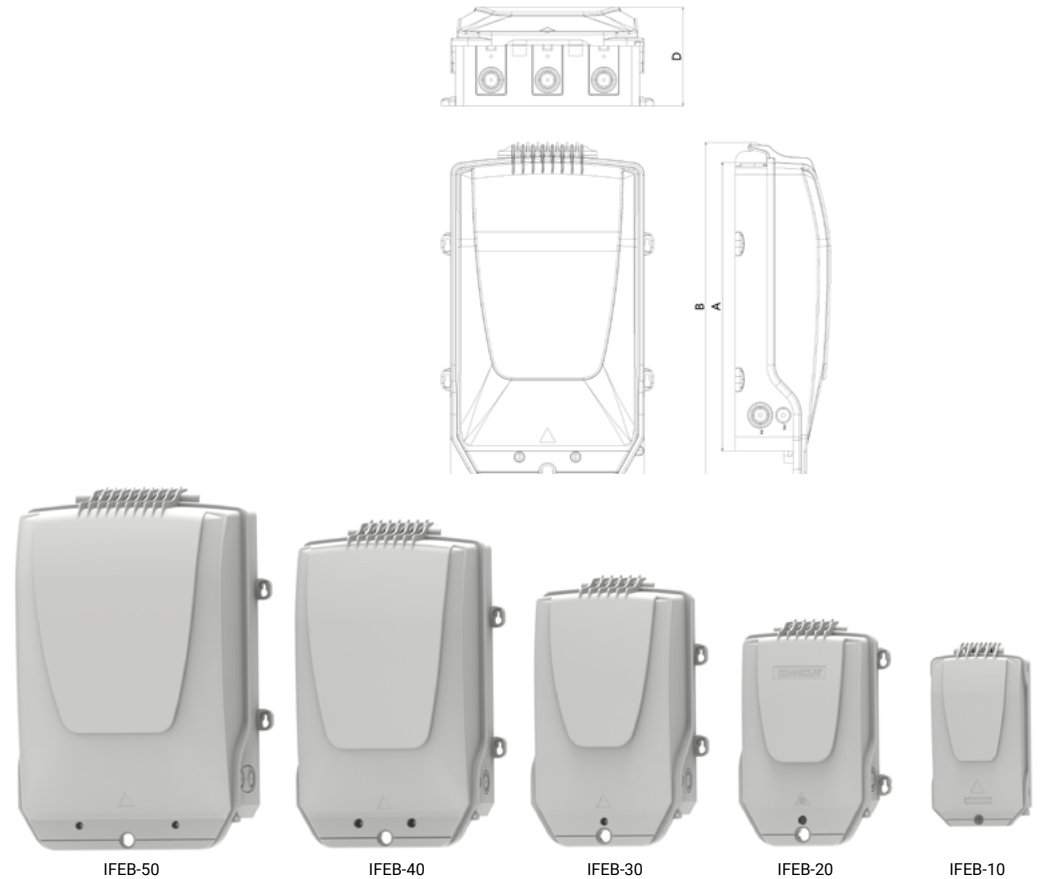

Size	IFEB-10	IFEB-20	IFEB-30	IFEB-40	IFEB-50
A: Height Box (mm)	260	274	340	425	340
B: Height Cover (mm)	285	349	420	500	550
C: Width (mm)	155	213	240	295	360
D: Depth (mm)	60	87	120	145	175

[Click here for the IFEB Ordering Guide](#)

Direct System Selection Index

Splice Closures	Building Entrance Solutions	FACT Optical Distribution Frame	Propel XFrame	19" Splice Solutions	Singlemode Fiber Cables	Pre-term 19" Fiber	Pre-term FACT ODF Fiber	Fiber Optic Patch Cords	FiberGuide	Copper Category 6A	Cable Management & Overhead Racks	FiberREACH
-----------------	-----------------------------	---------------------------------	---------------	----------------------	-------------------------	--------------------	-------------------------	-------------------------	------------	--------------------	-----------------------------------	------------

Architecture System Selection Index

Colocation Campus and Building Infrastructure

Fiber Entrance, Meet-Me Room	High Fiber Count DC Interconnect	Campus Cabling	Building Cabling	Campus Cabling for Wi-Fi and Security
------------------------------	----------------------------------	----------------	------------------	---------------------------------------

Customer Space Cabling Infrastructure

Overview	MDA Fiber	ToR Fiber	EoR Copper	FiberGuide Raceway
----------	-----------	-----------	------------	--------------------

Reference Designs and Technical Information

MDA Cabinet	MDA Cross-connect 19"	MDA Cross-connect FACT ODF	IDF FACT	IDF 19"
-------------	-----------------------	----------------------------	----------	---------



The FACT®-WR is a compact, sealed wall-mountable rack featuring a unique physical fiber management system. Designed for use in data center entrance rooms, exchanges, headends or customer premises. It is ideal for fiber entrance rooms and vault applications where outdoor cables are spliced to indoor cables. It also serves as a small optical distribution frame (ODF) for limited fiber counts.

As the successor to the FIST®-WR2 wall rack, the FACT-WR is fully compatible with CommScope’s advanced FACT chassis portfolio.

Available Size: 1,000 mm height—accommodates up to 28 FACT elements.

Features

- Supports all FACT chassis types, including splice only, patch/splice, and pre-cabled units
- Compact metal housing with a single lockable metal door and swing handle
- Designed for FACT mounting system without back plates, supports optional 19" panel installation
- 4 interchangeable cable inlet plates (top, bottom, left, right), 2 blanks, 2 with various knockout holes
- Includes an internal cable plate for cable separation, as a variation of different glands
- Installer-friendly wall attachment kit included with "hook on and attach" brackets, mountable at top/bottom or sides
- Integrated fiber management system with drums for flexible patching
- IP55 dust and splash-proof construction
- Intergrated RU attachment for 19" panels
- FACT and RU numbering



Description	Part Number	Dimensions HxWxD	Capacity FACT Elements	Max capacity ports with FACT		Max splice capacity with FACT	
				SC	LC	12 SMOUV® tray	Rollable ribbon
FACT-WR-28E	760260297	1000 x 840 x 330	28 FACT Elements	672 ports	1,344 ports	2,016	4,032

Direct System Selection Index

Splice Closures	Building Entrance Solutions	FACT Optical Distribution Frame	Propel XFrame	19" Splice Solutions	Singlemode Fiber Cables	Pre-term 19" Fiber	Pre-term FACT ODF Fiber	Fiber Optic Patch Cords	FiberGuide	Copper Category 6A	Cable Management & Overhead Racks	FiberREACH
-----------------	-----------------------------	---------------------------------	---------------	----------------------	-------------------------	--------------------	-------------------------	-------------------------	------------	--------------------	-----------------------------------	------------

Architecture System Selection Index

Colocation Campus and Building Infrastructure

Fiber Entrance, Meet-Me Room	High Fiber Count DC Interconnect	Campus Cabling	Building Cabling	Campus Cabling for Wi-Fi and Security
------------------------------	----------------------------------	----------------	------------------	---------------------------------------

Customer Space Cabling Infrastructure

Overview	MDA Fiber	ToR Fiber	EoR Copper	FiberGuide Raceway
----------	-----------	-----------	------------	--------------------

Reference Designs and Technical Information

MDA Cabinet	MDA Cross-connect 19"	MDA Cross-connect FACT ODF	IDF FACT	IDF 19"
-------------	-----------------------	----------------------------	----------	---------



FACT Splice Frame

Description	Dimensions HxWxD (mm)	Maximum Capacity	Part Number	Catalog Description
2.2 m splice frame	2200 x 900 x 300	60 FACT splice elements	760253816	FACT-FFRSPL22
All frame kits include: <ul style="list-style-type: none"> - Wall and back-to-back connection kit - Side-to-side connection kit - Earthing kit - Adjustable feet - Intuitive installation instructions - Color label kit for spool identification and intuitive patch cord routing - Required hardware and fasteners - Pre-installed position number identification strip for FACT style and 19" style 				

Doors and FiberGuide Fixation

Description	Part Number	Catalog Description
Door kit for 2.2 m interconnect frame and 2.2 m splice frame. Set of two doors per one frame, one door handle per set, lock included.	760243100	FACT-FFRICD22
Fiber Guide System (FGS) fixation kit	760243110	FACT-FRACCFGS
All frame accessory kits include: <ul style="list-style-type: none"> - Intuitive installation instruction - Required hardware and fasteners 		

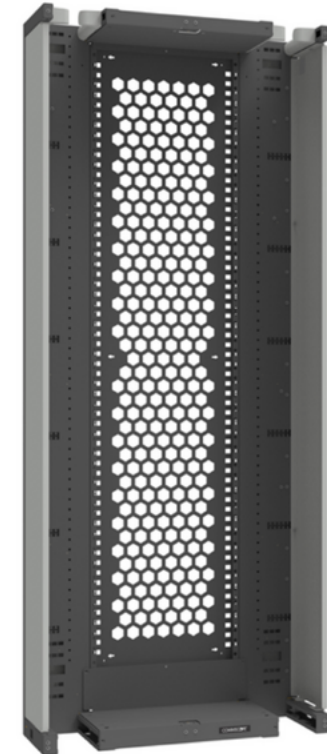

Direct System Selection Index

Splice Closures	Building Entrance Solutions	FACT Optical Distribution Frame	Propel XFrame	19" Splice Solutions	Singlemode Fiber Cables	Pre-term 19" Fiber	Pre-term FACT ODF Fiber	Fiber Optic Patch Cords	FiberGuide	Copper Category 6A	Cable Management & Overhead Racks	FiberREACH
-----------------	-----------------------------	---------------------------------	---------------	----------------------	-------------------------	--------------------	-------------------------	-------------------------	------------	--------------------	-----------------------------------	------------

Architecture System Selection Index

Colocation Campus and Building Infrastructure

Fiber Entrance, Meet-Me Room	High Fiber Count DC Interconnect	Campus Cabling	Building Cabling	Campus Cabling for Wi-Fi and Security
------------------------------	----------------------------------	----------------	------------------	---------------------------------------

Customer Space Cabling Infrastructure

Overview	MDA Fiber	ToR Fiber	EoR Copper	FiberGuide Raceway
----------	-----------	-----------	------------	--------------------

Reference Designs and Technical Information

MDA Cabinet	MDA Cross-connect 19"	MDA Cross-connect FACT ODF	IDF FACT	IDF 19"
-------------	-----------------------	----------------------------	----------	---------



Frame

The FACT optical distribution frame solution begins with CommScope's modular, lightweight FACT frame. Designed modularly with a small footprint, the fully front-accessible FACT frame can be placed against a wall or back-to-back in a quad formation to maximize usable density. The frame provides dedicated spots for cable routing and color-coded fiber management, supporting up to 2,880 LC connections in a single frame.

The cross-connect FACT frame can be designed and easily installed with cable routing on either side of the frame, which includes backplate numbering that allows for simple tracking of fibers whether you route from top to bottom or vice versa. One standard patch cord length can reach any position in a back-to-back configuration, reducing the number of cable lengths required.

The FACT frame accommodates not only FACT shelving, but standard 19"H shelving as well, allowing you to increase your density while utilizing your current equipment. The FACT frame is compatible with a range of accessories such as side panels, doors and cable attachment plates.

Elements and chassis

FACT elements may be deployed individually as a single-element chassis or grouped with other elements for higher density solutions. Each element measures 30.95 mm (1.22 inch) tall, 30% smaller than the standard HU (44.45 mm/1.75 inch). Each element supports two hinged trays that provide full front access to both sides of all connections and clear visibility of all ports. Four chassis types—patch-only, patch-splice, pre-cabled and NG4—enable customization of the FACT optical distribution frame to support virtually any application.

[Learn more about the FACT High Density ODF Solution here.](#)

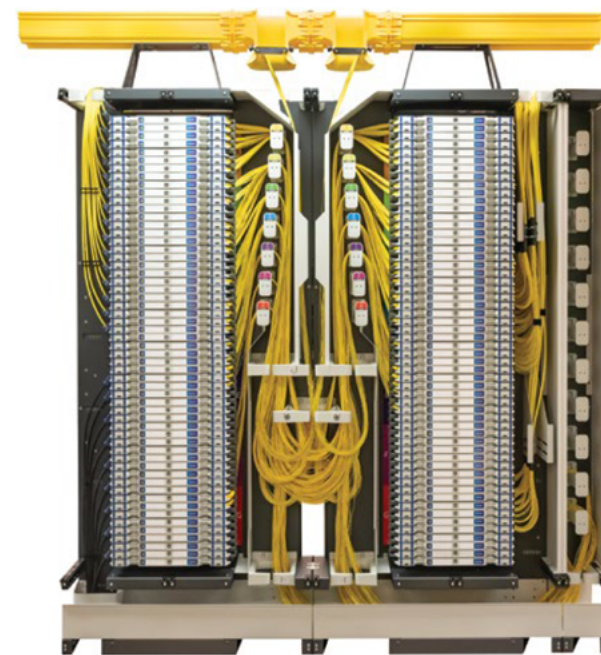

Direct System Selection Index

Splice Closures	Building Entrance Solutions	FACT Optical Distribution Frame	Propel XFrame	19" Splice Solutions	Singlemode Fiber Cables	Pre-term 19" Fiber	Pre-term FACT ODF Fiber	Fiber Optic Patch Cords	FiberGuide	Copper Category 6A	Cable Management & Overhead Racks	FiberREACH
-----------------	-----------------------------	---------------------------------	---------------	----------------------	-------------------------	--------------------	-------------------------	-------------------------	------------	--------------------	-----------------------------------	------------

Architecture System Selection Index

Colocation Campus and Building Infrastructure

Fiber Entrance, Meet-Me Room	High Fiber Count DC Interconnect	Campus Cabling	Building Cabling	Campus Cabling for Wi-Fi and Security
------------------------------	----------------------------------	----------------	------------------	---------------------------------------

Customer Space Cabling Infrastructure

Overview	MDA Fiber	ToR Fiber	EoR Copper	FiberGuide Raceway
----------	-----------	-----------	------------	--------------------

Reference Designs and Technical Information

MDA Cabinet	MDA Cross-connect 19"	MDA Cross-connect FACT ODF	IDF FACT	IDF 19"
-------------	-----------------------	----------------------------	----------	---------



Select a product for more information.

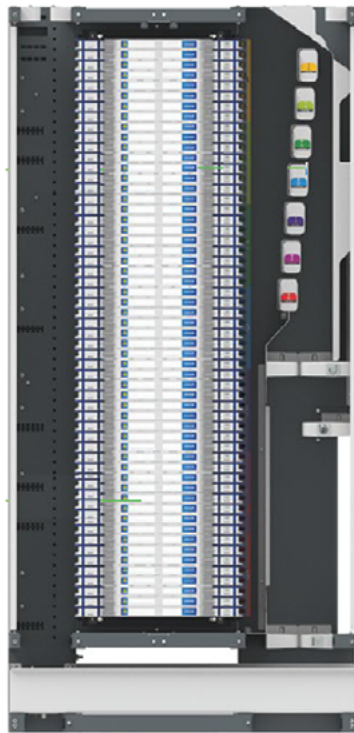

FACT Optical Distribution Frame

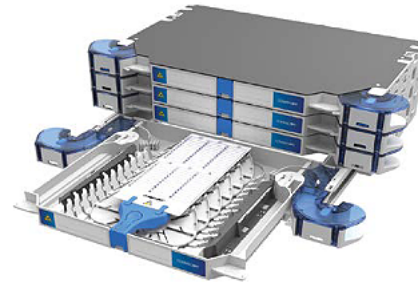

FACT Splice Chassis

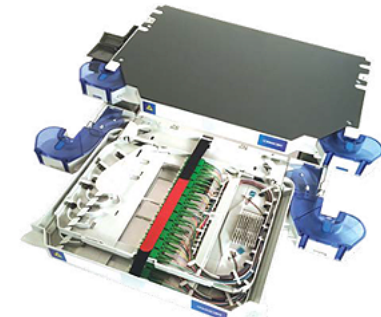

FACT Splice/Patch Chassis

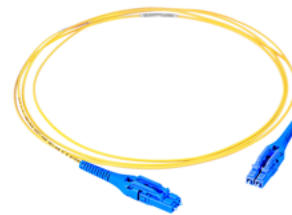

Uniboot singlemode LC patchcords



FACT Pre-cabled Chassis

Direct System Selection Index

Splice Closures	Building Entrance Solutions	FACT Optical Distribution Frame	Propel XFrame	19" Splice Solutions	Singlemode Fiber Cables	Pre-term 19" Fiber	Pre-term FACT ODF Fiber	Fiber Optic Patch Cords	FiberGuide	Copper Category 6A	Cable Management & Overhead Racks	FiberREACH
-----------------	-----------------------------	---------------------------------	---------------	----------------------	-------------------------	--------------------	-------------------------	-------------------------	------------	--------------------	-----------------------------------	------------

Architecture System Selection Index

Colocation Campus and Building Infrastructure

Fiber Entrance, Meet-Me Room	High Fiber Count DC Interconnect	Campus Cabling	Building Cabling	Campus Cabling for Wi-Fi and Security
------------------------------	----------------------------------	----------------	------------------	---------------------------------------

Customer Space Cabling Infrastructure

Overview	MDA Fiber	ToR Fiber	EoR Copper	FiberGuide Raceway
----------	-----------	-----------	------------	--------------------

Reference Designs and Technical Information

MDA Cabinet	MDA Cross-connect 19"	MDA Cross-connect FACT ODF	IDF FACT	IDF 19"
-------------	-----------------------	----------------------------	----------	---------



Review FACT Optical Distribution Frame (ODF) Modular Design here.

Frames	Dimensions	Max. Termination Capacity	Part Number	Catalog Description
Cross-connect frame, patching on the left	2200 mm x 1050 mm x 300 mm (87 in. x 41 in. x 12 in)	2688 single LC or 1344 SC connections per frame	760243094	FACT-FRCCLHP22
Cross-connect frame, patching on the right	2200 mm x 1050 mm x 300 mm (87 in. x 41 in. x 12 in)	2688 single LC or 1344 SC connections per frame	760243095	FACT-FRCCRHP22
Interconnect frame, patching on the right	2200 mm x 900 mm x 300 mm (87 in. x 35 in. x 12 in)	2880 single LC or 1440 SC connections per frame	760243096	FACT-FRICRHP22
Patch cord overlength management bay	2200 mm x 200 mm x 300 mm (87 in. x 8 in. x 12 in)	N/A	760243097	FACT-FROLB22

All frame kits include:

- Wall and back-to-back connection kit
- Side-to-side connection kit
- Earthing kit
- Adjustable feet
- Intuitive installation instructions
- Color label kit for spool identification and intuitive patch cord routing
- Required hardware and fasteners
- Pre-installed position number identification strip for FACT-style and 19"-style

All frame accessory kits include:

- Intuitive installation instruction
- Required hardware and fasteners

Frame Accessories	Part Number	Catalog Description
Door kit for 1.8 m cross-connect frame. Set of two doors for one frame, one door handle per set, lock included.	760245377	FACT-FRCCD18
Side panel kit for 1.8 m cross-connect frame (set of two panels for one frame).	760245378	FACT-FRCCP18
Door kit for 1.8 m patch cord overlength bay. Set of two doors for one frame, one door handle per set, lock included.	760245379	FACT-FROLBD18
Door kit for 2.2 m cross-connect frame. Set of two doors for one frame, one door handle per set, lock included	760243098	FACT-FRCCD22
Side panel kit for 2.2 m cross-connect frame (set of two panels for one frame).	760243099	FACT-FRCCP22
Door kit for 2.2 m patch cord overlength bay. Set of one door with door handle, lock included.	760243101	FACT-FROLBD22
Door kit for 2.2 m interconnect frame and 2.2 m splice frame. Set of two doors for one frame, one door handle per set, lock included.	760243100	FACT-FRICD22
FiberGuide System (FGS) fixation kit.	760243110	FACT-FRACCFGS

FACT Cable Attachment Plates	Compatible with Frame	Part Number	Catalog Description
One cable attachment plate for frame side duct and one cable-to-flex conversion component set	FACT	760243108	FACT-FRACCCAPL
One cable-to-flex conversion component set for cable attachment plate	FACT	760243111	FACT-FRACCCCTF
One fan-out fixation plate for frame side duct and eight fan-out fixation component sets	FACT	760243109	FACT-FRACCFOPU
Eight fan-out fixation component sets (for fan-out fixation plate)	FACT	760243112	FACT-FRACCFOPK-8

Direct System Selection Index

Splice Closures	Building Entrance Solutions	FACT Optical Distribution Frame	Propel XFrame	19" Splice Solutions	Singlemode Fiber Cables	Pre-term 19" Fiber	Pre-term FACT ODF Fiber	Fiber Optic Patch Cords	FiberGuide	Copper Category 6A	Cable Management & Overhead Racks	FiberREACH
-----------------	-----------------------------	---------------------------------	---------------	----------------------	-------------------------	--------------------	-------------------------	-------------------------	------------	--------------------	-----------------------------------	------------

Architecture System Selection Index

Colocation Campus and Building Infrastructure

Fiber Entrance, Meet-Me Room	High Fiber Count DC Interconnect	Campus Cabling	Building Cabling	Campus Cabling for Wi-Fi and Security
------------------------------	----------------------------------	----------------	------------------	---------------------------------------

Customer Space Cabling Infrastructure

Overview	MDA Fiber	ToR Fiber	EoR Copper	FiberGuide Raceway
----------	-----------	-----------	------------	--------------------

Reference Designs and Technical Information

MDA Cabinet	MDA Cross-connect 19"	MDA Cross-connect FACT ODF	IDF FACT	IDF 19"
-------------	-----------------------	----------------------------	----------	---------



Review FACT Optical Distribution Frame (ODF) Modular Design here.

FACT Cable Termination Units	Element Type	Description Code	Part Number
FACT cable termination unit (CTU), kit for 6E FACT chassis, accommodates: 1 cable 2.5-14 mm or 2 cables 2.5-8.5 mm or 4 cables 2.5-5 mm or 1 flex tube OD 16 mm, only for use in FACT frame	CTU	FACT-FRACCCTU6E	760243107
FACT cable termination unit (CTU), kit for 4E FACT chassis, accommodates: 1 cable 2.5-14 mm or 2 cables 2.5-8.5 mm or 4 cables 2.5-5 mm or 1 flex tube OD 16 mm, only for use in FACT frame	CTU	FACT-FRACCCTU4E	760243105
FACT cable termination unit (CTU), kit for 3E FACT chassis, accommodates: 1 cable 2.5-14 mm or 2 cables 2.5-8.5 mm or 4 cables 2.5-5 mm or 1 flex tube OD 16 mm, only for use in FACT frame	CTU	FACT-FRACCCTU3E	760243104
FACT cable termination unit (CTU), kit for 2E FACT chassis, accommodates: 1 cable 2.5-14 mm or 2 cables 2.5-8.5 mm or 4 cables 2.5-5 mm or 1 flex tube OD 16 mm, only for use in FACT frame	CTU	FACT-FRACCCTU2E	760243103
FACT cable termination unit (CTU), kit for 1E FACT chassis, accommodates: 1 cable 2.5-14 mm or 2 cables 2.5-8.5 mm or 4 cables 2.5-5 mm or 1 flex tube OD 16 mm, only for use in FACT frame	CTU	FACT-FRACCCTU1E	760243102
FACT® Cable Termination Unit (CTU) for one cable with max. diameter of 8.5 mm, two units per kit	CTU	FACT-ACCCTUSLT	760239952
FACT Cable Termination Unit (CTU) for IFC-cables with max. diameter of 8.5 mm, two units per kit	CTU	FACT-ACCCTUSIFC	760239951
FACT Cable Termination Unit (CTU) for IFC-cables with max. diameter of 8.5 mm for one or 6 mm for two cables	CTU	FACT-ACCCTUMIFC	760239899
FACT Cable Termination Unit (CTU) for one cable with max. diameter of 15 mm or one flex tube of 12-16 mm	CTU	FACT-ACCCTUMLT	760239898
FACT Cable Termination Unit (CTU) for one cable with max. diameter of 15 mm or one flex tube of 12-16 mm (with transparent cover)	CTU	FACT-ACCCTULLT	760239897
FACT Cable Termination Unit (CTU) for 6 cables with max. diameter of 7 mm	CTU	FACT-ACCCTU6X7MM	760249062

All frame kits include:

- Wall and back-to-back connection kit
- Side-to-side connection kit
- Earthing kit
- Adjustable feet
- Intuitive installation instructions
- Color label kit for spool identification and intuitive patch cord routing
- Required hardware and fasteners
- Pre-installed position number identification strip for FACT-style and 19"-style

All frame accessory kits include:

- Intuitive installation instruction
- Required hardware and fasteners

Cable Unit Breakout Kit	Description Code	Part Number
Cable unit breakout kit for low fiber count loose tube cables (max 24 mm), 1 cable to max 6 flex tubes (ID 6 mm, not included). Cable application range subject of loose tube diameter and stiffness (indicatively: max 288f cable with 1.7 mm loose tube).	CO-CUB-S	760258254
Cable unit breakout kit for low to medium fiber count loose tube cables (max 24 mm), 1 cable to 6 flex tubes (ID 12 mm, not included). Cable application range subject of loose tube diameter and stiffness (indicatively: max 864f cable with 1.7 mm loose tube).	CO-CUB-M	760258255
Cable unit breakout kit for medium to high fiber count central core or ribbon cables (max 24 mm), 1 cable to max 6 flex tubes (ID 12 mm, not included) max 288 fiber per flex. (max 1728f per cable).	CO-CUB-M-HFC	760259098

Direct System Selection Index

Splice Closures	Building Entrance Solutions	FACT Optical Distribution Frame	Propel XFrame	19" Splice Solutions	Singlemode Fiber Cables	Pre-term 19" Fiber	Pre-term FACT ODF Fiber	Fiber Optic Patch Cords	FiberGuide	Copper Category 6A	Cable Management & Overhead Racks	FiberREACH
-----------------	-----------------------------	---------------------------------	---------------	----------------------	-------------------------	--------------------	-------------------------	-------------------------	------------	--------------------	-----------------------------------	------------

Architecture System Selection Index

Colocation Campus and Building Infrastructure

Fiber Entrance, Meet-Me Room	High Fiber Count DC Interconnect	Campus Cabling	Building Cabling	Campus Cabling for Wi-Fi and Security
------------------------------	----------------------------------	----------------	------------------	---------------------------------------

Customer Space Cabling Infrastructure

Overview	MDA Fiber	ToR Fiber	EoR Copper	FiberGuide Raceway
----------	-----------	-----------	------------	--------------------

Reference Designs and Technical Information

MDA Cabinet	MDA Cross-connect 19"	MDA Cross-connect FACT ODF	IDF FACT	IDF 19"
-------------	-----------------------	----------------------------	----------	---------



Review FACT Optical Distribution Frame (ODF) Modular Design here.

FACT Splice-Patch Chassis

FACT- XX X H P XX X

Element count

1E	One element
2E	Two elements
3E	Three elements
4E	Four elements
5E	Five elements
6E	Six elements

Patch cord side

L	Left-hand patch
R	Right-hand patch

Splice holder/protector (included)

S	SMOUV
A	ANT
R	12f rollable ribbon (only LC)

Adaptor/connector types, Port count

L1	LC UPC, C-grade, 48 single LC ports per element
L2	LC APC, C-grade, 48 single LC ports per element
LF	LC UPC, B-grade, 48 single LC ports per element
LG	LC APC, B-grade, 48 single LC ports per element
L4	LC OM4, 48 single LC ports per element

*Single mode connector performance grades B & C according to IEC 61755-1.

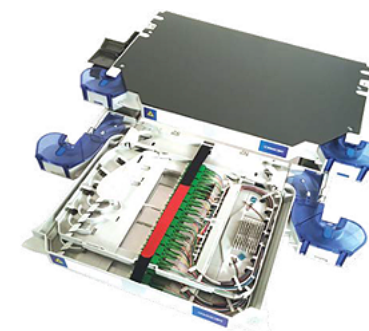

Color Coding

Fiber 1	Blue
Fiber 2	Orange
Fiber 3	Green
Fiber 4	Brown
Fiber 5	Grey
Fiber 6	White
Fiber 7	Red
Fiber 8	Black
Fiber 9	Yellow
Fiber 10	Purple
Fiber 11	Pink
Fiber 12	Turquoise

Note: All fibered standard FACT products us EIA/TIA 598 color coding

Direct System Selection Index

Splice Closures	Building Entrance Solutions	FACT Optical Distribution Frame	Propel XFrame	19" Splice Solutions	Singlemode Fiber Cables	Pre-term 19" Fiber	Pre-term FACT ODF Fiber	Fiber Optic Patch Cords	FiberGuide	Copper Category 6A	Cable Management & Overhead Racks	FiberREACH
-----------------	-----------------------------	---------------------------------	---------------	----------------------	-------------------------	--------------------	-------------------------	-------------------------	------------	--------------------	-----------------------------------	------------

Architecture System Selection Index

Colocation Campus and Building Infrastructure

Fiber Entrance, Meet-Me Room	High Fiber Count DC Interconnect	Campus Cabling	Building Cabling	Campus Cabling for Wi-Fi and Security
------------------------------	----------------------------------	----------------	------------------	---------------------------------------

Customer Space Cabling Infrastructure

Overview	MDA Fiber	ToR Fiber	EoR Copper	FiberGuide Raceway
----------	-----------	-----------	------------	--------------------

Reference Designs and Technical Information

MDA Cabinet	MDA Cross-connect 19"	MDA Cross-connect FACT ODF	IDF FACT	IDF 19"
-------------	-----------------------	----------------------------	----------	---------



Review FACT Optical Distribution Frame (ODF) Modular Design here.

FACT Splice Chassis

Splice Holder	Part Number	Catalog Description	Splices per Tray	Trays per FACT Chassis	Fiber per Chassis
SMOUV (heat shrink, 45 mm single fiber)	760239957	FACT-1ESPLS04	4	12	48
	760239961	FACT-2ESPLS04		24	96
	760239965	FACT-3ESPLS04		36	144
	760239972	FACT-4ESPLS04		48	192
	760239959	FACT-1ESPLS12	12	6	72
	760239963	FACT-2ESPLS12		12	144
	760239967	FACT-3ESPLS12		18	216
	760239970	FACT-4ESPLS12		24	288
ANT or micro SMOUV (heat shrink, 30 mm single fiber)	760239958	FACT-1ESPLA04	4	12	48
	760239962	FACT-2ESPLA04		24	96
	760239966	FACT-3ESPLA04		36	144
	760239971	FACT-4ESPLA04		48	192
	760239960	FACT-1ESPLA12	12	8	96
	760239964	FACT-2ESPLA12		16	192
	760239968	FACT-3ESPLA12		24	288
	760239969	FACT-4ESPLA12		32	384
SMOUV 12f ribbon	760254635	FACT-1ESPLR02	2 x 12f (*)	6	144 (*)
	760254636	FACT-2ESPLR02		12	288 (*)
	760254637	FACT-3ESPLR02		18	432 (*)
	760254638	FACT-4ESPLR02		24	576 (*)
	760254639	FACT-5ESPLR02		30	720 (*)
	760254640	FACT-6ESPLR02		36	864 (*)

Direct System Selection Index

Splice Closures	Building Entrance Solutions	FACT Optical Distribution Frame	Propel XFrame	19" Splice Solutions	Singlemode Fiber Cables	Pre-term 19" Fiber	Pre-term FACT ODF Fiber	Fiber Optic Patch Cords	FiberGuide	Copper Category 6A	Cable Management & Overhead Racks	FiberREACH
-----------------	-----------------------------	---------------------------------	---------------	----------------------	-------------------------	--------------------	-------------------------	-------------------------	------------	--------------------	-----------------------------------	------------

Architecture System Selection Index

Colocation Campus and Building Infrastructure

Fiber Entrance, Meet-Me Room	High Fiber Count DC Interconnect	Campus Cabling	Building Cabling	Campus Cabling for Wi-Fi and Security
------------------------------	----------------------------------	----------------	------------------	---------------------------------------

Customer Space Cabling Infrastructure

Overview	MDA Fiber	ToR Fiber	EoR Copper	FiberGuide Raceway
----------	-----------	-----------	------------	--------------------

Reference Designs and Technical Information

MDA Cabinet	MDA Cross-connect 19"	MDA Cross-connect FACT ODF	IDF FACT	IDF 19"
-------------	-----------------------	----------------------------	----------	---------



Review FACT Optical Distribution Frame (ODF) Modular Design here.

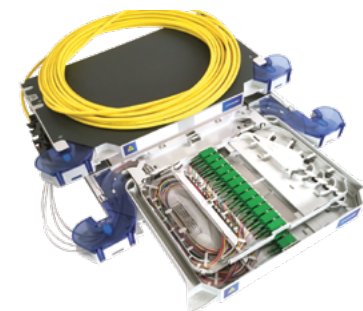

FACT Pre-cabled Chassis

FACT- XX X H P XX X - XXX XX

Element count

1E	One element
2E	Two elements
3E	Three elements
4E	Four elements
5E	Five elements
6E	Six elements

Patch cord side

L	Left-hand patch
R	Right-hand patch

Adaptor/connector types, Port count

L1	LC UPC, C-grade, 48 single LC ports per element
L2	LC APC, C-grade, 48 single LC ports per element
LF	LC UPC, B-grade, 48 single LC ports per element
LG	LC APC, B-grade, 48 single LC ports per element
L4	LC OM4, 48 single LC ports per element

* Single mode connector performance grades B & C according to IEC 61755-1.

Cable length

010	10 m (33 ft.)	100	100 m (328 ft.)
020	20 m (66 ft.)	150	150 m (492 ft.)
030	30 m (98 ft.)	200	200 m (656 ft.)
050	50 m (164 ft.)	250	250 m (820 ft.)
075	75 m (246 ft.)	300	300 m (984 ft.)

Splice holder/protector

S	SMOUV
A	ANT

Color Coding

Fiber 1	Blue
Fiber 2	Orange
Fiber 3	Green
Fiber 4	Brown
Fiber 5	Grey
Fiber 6	White
Fiber 7	Red
Fiber 8	Black
Fiber 9	Yellow
Fiber 10	Purple
Fiber 11	Pink
Fiber 12	Turquoise

Note: All fibered standard FACT products us EIA/TIA 598 color coding

Cable type

ID	24 fiber Indoor Micro-Tube cable, SM G657A1 = yellow; OM4 = Aqua, EN50575 CPR Cable EuroClass Dca
IF	48 fiber Indoor Micro-Tube cable, SM G657A1 = yellow; OM4 = Aqua, EN50575 CPR Cable EuroClass Dca
IG	72 fiber Indoor Micro-Tube cable, SM G657A1 = yellow; OM4 = Aqua, EN50575 CPR Cable EuroClass Dca
IK	96 fiber Indoor Micro-Tube cable, SM G657A1 = yellow; OM4 = Aqua, EN50575 CPR Cable EuroClass Dca
IH	144 fiber Indoor Micro-Tube cable, SM G657A1 = yellow; OM4 = Aqua, EN50575 CPR Cable EuroClass Dca
CD	24 fiber Indoor Micro-Tube cable, Fiber: G657A1, Yellow jacket, EN50575 CPR Cable EuroClass Cca
CF	48 fiber Indoor Micro-Tube cable, Fiber: G657A1, Yellow jacket, EN50575 CPR Cable EuroClass Cca
CG	72 fiber Indoor Micro-Tube cable, Fiber: G657A1, Yellow jacket, EN50575 CPR Cable EuroClass Cca
CK	96 fiber Indoor Micro-Tube cable, Fiber: G657A1, Yellow jacket, EN50575 CPR Cable EuroClass Cca
CH	144 fiber Indoor Micro-Tube cable, Fiber: G657A1, Yellow jacket, EN50575 CPR Cable EuroClass Cca
OD	24 fiber In/Outdoor Microsheath Breakout cable, G657A1, black, EN50575 CPR Cable EuroClass Dca
OF	48 fiber In/Outdoor Microsheath cable, G657A1, black, EN50575 CPR Cable EuroClass Dca
OG	72 fiber In/Outdoor Microsheath cable, G657A1, black, EN50575 CPR Cable EuroClass Dca
OK	96 fiber In/Outdoor Microsheath cable (SM = black), G657A1, black, EN50575 CPR Cable EuroClass Dca
OH	144 fiber In/Outdoor Microsheath cable (SM = black), G657A1, black, EN50575 CPR Cable EuroClass Dca

Note: Cable fiber count needs to match the FACT-chassis port count

Direct System Selection Index

Splice Closures	Building Entrance Solutions	FACT Optical Distribution Frame	Propel XFrame	19" Splice Solutions	Singlemode Fiber Cables	Pre-term 19" Fiber	Pre-term FACT ODF Fiber	Fiber Optic Patch Cords	FiberGuide	Copper Category 6A	Cable Management & Overhead Racks	FiberREACH
-----------------	-----------------------------	---------------------------------	---------------	----------------------	-------------------------	--------------------	-------------------------	-------------------------	------------	--------------------	-----------------------------------	------------

Architecture System Selection Index

Colocation Campus and Building Infrastructure

Fiber Entrance, Meet-Me Room	High Fiber Count DC Interconnect	Campus Cabling	Building Cabling	Campus Cabling for Wi-Fi and Security
------------------------------	----------------------------------	----------------	------------------	---------------------------------------

Customer Space Cabling Infrastructure

Overview	MDA Fiber	ToR Fiber	EoR Copper	FiberGuide Raceway
----------	-----------	-----------	------------	--------------------

Reference Designs and Technical Information

MDA Cabinet	MDA Cross-connect 19"	MDA Cross-connect FACT ODF	IDF FACT	IDF 19"
-------------	-----------------------	----------------------------	----------	---------



Propel XFrame

Simplified, agile and open

The modular Propel XFrame solution supports Propel™ modules and adapters. It accepts multiple connector types and up to 1,920 LC duplex, 3,072 SN duplex or 1,920 MPO connectors.

Its simple layout and operation enable less-skilled technicians to easily and quickly add, change, reroute and reconfigure fiber connections, breakout assemblies and panel components as needed.

With a completely modular design, it also significantly reduces the number of SKUs that need to be ordered and managed.

Propel XFrame solution at a glance

- Low profile: 30 cm/11.8 inches (d)
120 cm/47.2 inches (w)
222.8 cm/87.7 in (h)
- 3U, 4U and 5U fixed front access panels
- Place against a wall, back-to-back or free-standing
- Uses Propel modules and cassettes
- Horizontal or vertical cable management
- Options: Lockable doors, side panels, splicing, troughs
- Single patch cord length
- Supports preterminated breakout assembly and splicing
- Accommodates up to 1,920 LC duplex, 3,072 SN duplex or 1,920 MPO connectors
- Accepts duplex LC/SN and MPO8 - MPO16 connectors



Direct System Selection Index

Splice Closures	Building Entrance Solutions	FACT Optical Distribution Frame	Propel XFrame	19" Splice Solutions	Singlemode Fiber Cables	Pre-term 19" Fiber	Pre-term FACT ODF Fiber	Fiber Optic Patch Cords	FiberGuide	Copper Category 6A	Cable Management & Overhead Racks	FiberREACH
-----------------	-----------------------------	---------------------------------	---------------	----------------------	-------------------------	--------------------	-------------------------	-------------------------	------------	--------------------	-----------------------------------	------------

Architecture System Selection Index

Colocation Campus and Building Infrastructure

Fiber Entrance, Meet-Me Room	High Fiber Count DC Interconnect	Campus Cabling	Building Cabling	Campus Cabling for Wi-Fi and Security
------------------------------	----------------------------------	----------------	------------------	---------------------------------------

Customer Space Cabling Infrastructure

Overview	MDA Fiber	ToR Fiber	EoR Copper	FiberGuide Raceway
----------	-----------	-----------	------------	--------------------

Reference Designs and Technical Information

MDA Cabinet	MDA Cross-connect 19"	MDA Cross-connect FACT ODF	IDF FACT	IDF 19"
-------------	-----------------------	----------------------------	----------	---------



Frame options

Part Number	Part Number	Detailed Description
760258350	PPL-FRAME-KT	Propel Frame without Doors. Includes Frame components with spools & back panels; no doors or side panels, 40RU
760258349	PPL-FRAME-KT-WDRS	Propel Frame with Doors. Includes Frame components with spools, back panels & 2 locking doors with keys; no side panels, 40RU

Panel options

VCM (Vertical Cable Management) panels: With VCM panels, patch cords are routed straight down to a trough and then over. This provides finger access for moves, adds, and changes

Part Number	Part Number	Detailed Description
760258355	PPL-FA-4U-VCM	Propel Front Access Panel, 4RU, Vertical Cable Management. For use with 12f Propel components, 24 per panel
760258357	PPL-FA-5U-VCM	Propel Front Access Panel, 5RU, Vertical Cable Management. For use with 8f, 48 per panel or 16f, 24 per panel Propel components

HCM (Horizontal Cable Management) panels: HCM panels maximize density within the frame. Patch cords are routed across the front of the frame, providing maximum frame density

Part Number	Part Number	Detailed Description
760258354	PPL-FA-3U-HCM	Propel Front Access Panel, 3RU, Horizontal Cable Management. For use with 12f Propel components, 24 per panel
760258356	PPL-FA-4U-HCM	Propel Front Access Panel, 4RU, Horizontal Cable Management. For use with 8f, 48 per panel or 16f, 24 per panel Propel components

Accessories

Part Number	Part Number	Detailed Description
760258348	PPL-FRAME-SPLC-KT	Propel Frame Splicing Kit. For in bay bulk splicing. Includes 2 Splice Tree assemblies with fasteners and side panel radius limiters/clips. Splice trays sold separately.
760258367	PPL-FRAME-SDPNL-KT	Propel Frame Side Panel Kit. Includes 2 Side Panel assemblies with fasteners
760258368	PPL-FRAME-TROUGH-KT	Propel Frame Top Trough. For routing fibers across the top of the frame to another adjacent Propel XFrame Includes Top Trough assembly with fasteners
FGS-HCTS-A/B	FGS-HCTS-A/B	FiberGuide® Adjustable Top of Frame Bracket Kit, 4x4, 2x6, 4x6in, Black
760243050	FOST-ACC-D-TRAY-RR-288-KIT	288 fiber splicing tray

Recommended patch cord length of 5 meters and trunk cable breakout length of 60 inches

Propel XFrame modules

Propel XFrame can use 8 fiber, 12 fiber and 16 fiber Propel Modules, Propel Adapter Packs, Propel Splice Cassettes and Propel Cabled Modules (CMODs). [See here](#)

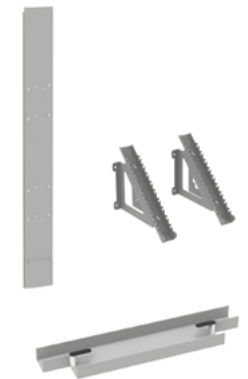

Direct System Selection Index

Splice Closures	Building Entrance Solutions	FACT Optical Distribution Frame	Propel XFrame	19" Splice Solutions	Singlemode Fiber Cables	Pre-term 19" Fiber	Pre-term FACT ODF Fiber	Fiber Optic Patch Cords	FiberGuide	Copper Category 6A	Cable Management & Overhead Racks	FiberREACH
---------------------------------	---	---	-------------------------------	--------------------------------------	---	------------------------------------	---	---	----------------------------	------------------------------------	---	----------------------------

Architecture System Selection Index

Colocation Campus and Building Infrastructure

Fiber Entrance, Meet-Me Room	High Fiber Count DC Interconnect	Campus Cabling	Building Cabling	Campus Cabling for Wi-Fi and Security
--	--	--------------------------------	----------------------------------	---

Customer Space Cabling Infrastructure

Overview	MDA Fiber	ToR Fiber	EoR Copper	FiberGuide Raceway
--------------------------	---------------------------	---------------------------	----------------------------	------------------------------------

Reference Designs and Technical Information

MDA Cabinet	MDA Cross-connect 19"	MDA Cross-connect FACT ODF	IDF FACT	IDF 19"
-----------------------------	---------------------------------------	--	--------------------------	-------------------------



EPX
48 ports LC-D or 32 ports MPO
No cable management
Basic labeling

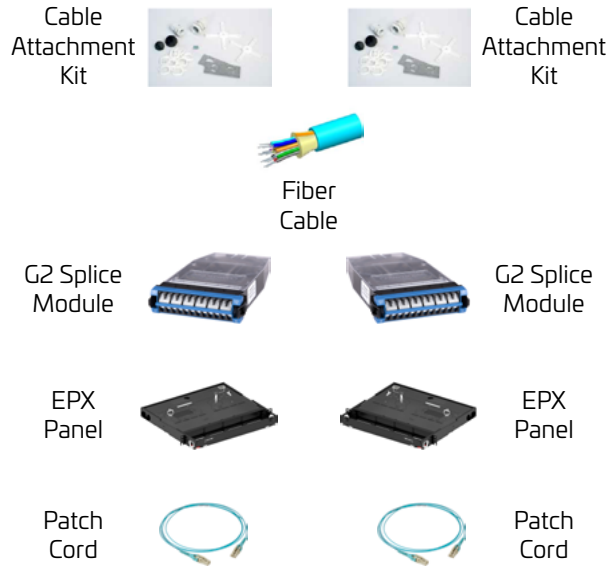

Propel
72 ports LC-D or 72 ports MPO
Front cable management
Labeling option (printer support)
Sliding tray for better cable modules access

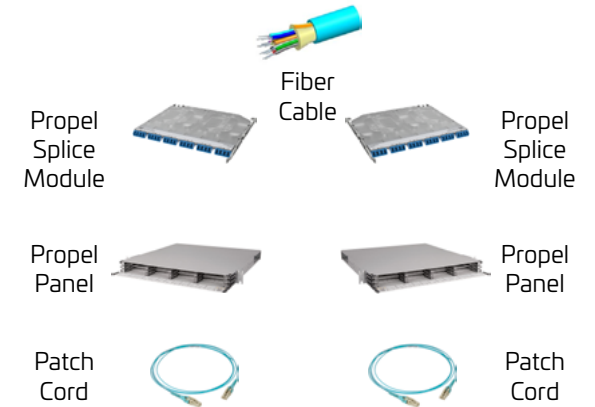

Modular Front Patching System (MFPS)
1U, 2U and 3U
Total of 48, 96 or 144f per panel
Available with LSH connector
Full front panel access and port-level fiber identification

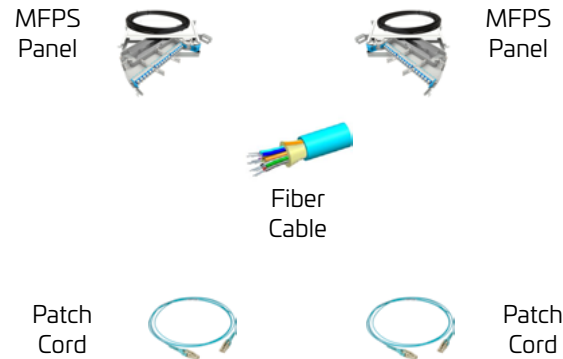

Direct System Selection Index

Splice Closures	Building Entrance Solutions	FACT Optical Distribution Frame	Propel XFrame	19" Splice Solutions	Singlemode Fiber Cables	Pre-term 19" Fiber	Pre-term FACT ODF Fiber	Fiber Optic Patch Cords	FiberGuide	Copper Category 6A	Cable Management & Overhead Racks	FiberREACH
-----------------	-----------------------------	---------------------------------	---------------	----------------------	-------------------------	--------------------	-------------------------	-------------------------	------------	--------------------	-----------------------------------	------------

Architecture System Selection Index

Colocation Campus and Building Infrastructure

Fiber Entrance, Meet-Me Room	High Fiber Count DC Interconnect	Campus Cabling	Building Cabling	Campus Cabling for Wi-Fi and Security
------------------------------	----------------------------------	----------------	------------------	---------------------------------------

Customer Space Cabling Infrastructure

Overview	MDA Fiber	ToR Fiber	EoR Copper	FiberGuide Raceway
----------	-----------	-----------	------------	--------------------

Reference Designs and Technical Information

MDA Cabinet	MDA Cross-connect 19"	MDA Cross-connect FACT ODF	IDF FACT	IDF 19"
-------------	-----------------------	----------------------------	----------	---------



Review 19" Splice Solutions System Selection here.

EPX MFPS

Fits to	EPX Panels			Description Code	Part Number
	EPX 1U sliding panel, accepts (4) G2 style splice cassettes, modules or adapter packs, providing up to 48 duplex LC ports			EPX-1U-MOD-ENC	760249998
Fits to	Splice Accessories			Description Code	Part Number
	Cable Attachment Kit for EPX fiber panel				1671273-1
	Fiber optic splice tray, stackable, for SMOUV splice protectors, 48 splices per tray, SMOUVs and SMOUV holder included			EPX-SPLICE-48	760241378
	Fiber optic splice tray, stackable, 24 splices per tray, for ANT splice protectors, ANT holder included, ANT splice protector to be ordered separately				760245882
	ANT splice protector (qty.: 150)				182398-000
Fits to	G2 Adapter Packs	Fiber	Module	Description Code	Part Number
	G2 Distribution Adapter Pack 12 LC with internal shutters, Multimode OM4 Aqua	OM4	Adapter Pack	360DPis-24LC-LS	760216754
	G2 Distribution Adapter Pack 24 LC with internal shutters, Multimode OM5 Lime Green	OM5	Adapter Pack	360DPis-24LC-WB	760236041
	G2 Distribution Adapter Pack 12 LC with internal shutters, Singlemode Blue	OS2	Adapter Pack	360DPis-24LC-SM	760216762
Fits to	G2 Splice Modules	Fiber	Module	Description Code	Part Number
	G2 Splice Cassette 24 LC, OM4, including pigtails, Polarity enhanced Method B	OM4	G2	G2-SP-12LC-SM-PT-BE	760258200
	G2 Splice Cassette 24 LC, OS2, including pigtails, Polarity enhanced Method B	OS2	G2	G2-SP-24LC-OM4-PT-BE	760258205
	G2 Splice Cassette 24 LC, OM4, including pigtails, Polarity straight pairs	OM4	G2	G2-SP-24LC-OM4-PT	760258202
	G2 Splice Cassette 24 LC, OS2, including pigtails, Polarity straight pairs	OS2	G2	G2-SP-24LC-SM-PT	760258028
	G2 blank adapters, 4 pcs	N/A	N/A	360G2-MOD-BLANK-4PK	760109462

Fits to	MFPS Patch-Splice Shelves	Total Number of Fibers	Patch Cord Entry Side	Connector, Splice Type, IEC Attenuation Grade	Description Code	Part Number
	MFPS Fiber Optic Panel, 19", 1RU, 48 fibers/HU, splice/patch, ANT/left, 48 LSH/APC, grade B	48	Left	LSH/APC, ANT, B	MFPS-KHD-P-SLE9-048	760248533
	MFPS Fiber Optic panel, 19", 1RU, 48 fibers/HU, splice/patch, ANT/right, 48 LSH/APC, grade B	48	Right	LSH/APC, ANT, B	MFPS-KHD-P-SJE9-048	760244694
	MFPS Fiber Optic Panel, 19", 2RU, 48 fibers/HU, splice/patch, ANT/left, LSH/APC, grade B	96	Left	LSH/APC, ANT, B	MFPS-JHD-P-SLE9-096	760248534
	MFPS Fiber Optic panel, 19", 2RU, 48 fibers/HU, splice/patch, ANT/right, 96 LSH/APC, grade B	96	Right	LSH/APC, ANT, B	MFPS-JHD-P-SJE9-096	760244695
	MFPS Fiber Optic Panel, 19", 3RU, 48 fibers/HU, splice/patch, ANT/left, 144 LSH, grade B	144	Left	LSH/APC, ANT, B	MFPS-IHD-P-SLE9-144	760248535
	MFPS Fiber Optic panel, 19", 3RU, 48 fibers/HU, splice/patch, ANT/right, 144 LSH/APC, grade B	144	Right	LSH/APC, ANT, B	MFPS-IHD-P-SJE9-144	760244696

Direct System Selection Index

Splice Closures	Building Entrance Solutions	FACT Optical Distribution Frame	Propel XFrame	19" Splice Solutions	Singlemode Fiber Cables	Pre-term 19" Fiber	Pre-term FACT ODF Fiber	Fiber Optic Patch Cords	FiberGuide	Copper Category 6A	Cable Management & Overhead Racks	FiberREACH
-----------------	-----------------------------	---------------------------------	---------------	----------------------	-------------------------	--------------------	-------------------------	-------------------------	------------	--------------------	-----------------------------------	------------

Architecture System Selection Index

Colocation Campus and Building Infrastructure

Fiber Entrance, Meet-Me Room	High Fiber Count DC Interconnect	Campus Cabling	Building Cabling	Campus Cabling for Wi-Fi and Security
------------------------------	----------------------------------	----------------	------------------	---------------------------------------

Customer Space Cabling Infrastructure

Overview	MDA Fiber	ToR Fiber	EoR Copper	FiberGuide Raceway
----------	-----------	-----------	------------	--------------------

Reference Designs and Technical Information

MDA Cabinet	MDA Cross-connect 19"	MDA Cross-connect FACT ODF	IDF FACT	IDF 19"
-------------	-----------------------	----------------------------	----------	---------



Review 19" Splice Solutions System Selection here.

Propel

Fits to	Propel Fiber Panels - Sliding	HU	Description Code	Part Number		
■	Propel 1RU sliding tray fiber panel, accepts Propel ULL modules or adapter packs, providing up to 72 duplex LC ports, 72 MPO ports or 144 SN ports (288f)	1	PPL-1U	760252002		
	Propel 2RU sliding tray fiber panel, accepts Propel ULL modules or adapter packs, providing up to 144 duplex LC ports, 144 MPO ports or 288 SN ports (576f)	2	PPL-2U	760252003		
	Propel 4RU sliding tray fiber panel, accepts Propel ULL modules or adapter packs, providing up to 288 duplex LC ports, 288 MPO ports or 576 SN ports (1152f)	4	PPL-4U	760252004		
Fits to	Propel Fiber Panels - Fixed	HU	Description Code	Part Number		
■	Propel 1RU fixed tray fiber panel, accepts Propel components, providing up to 48 duplex LC ports, 48 MPO ports or 96 SN ports (192f)	1	PPL-1U-HD-FX	760253796		
	Propel 2RU fixed tray fiber panel, accepts Propel ULL modules or adapter packs, providing up to 96 duplex LC ports, 96 MPO ports or 192 SN ports (384f)	2	PPL-2U-HD-FX	760253797		
	Propel 4RU fixed tray fiber panel, accepts Propel ULL modules or adapter packs, providing up to 192 duplex LC ports, 192 MPO ports or 384 SN ports (768f)	4	PPL-4U-HD-FX	760253798		
Fits to	Propel Fiber Panels - Fixed, Open Rear	HU	Description Code	Part Number		
■	Propel 1RU fixed tray open fiber panel, accepts Propel components, providing up to 48 duplex LC ports, 48 MPO ports or 96 SN ports (192f)	1	PPL-1U-HD-FX-OPEN	760254865		
	Propel 2RU fixed tray open fiber panel, accepts Propel components, providing up to 96 duplex LC ports, 96 MPO ports or 192 SN ports (384f)	2	PPL-2U-HD-FX-OPEN	760254908		
Fits to	Splice Cassettes	Fiber	Type	Polarity Method	Description Code	Part Number
■	Propel Multimode Splice Cassette, 24LC/UPC with internal shutters, OM4 250µm single fiber pigtails, Method B Enhanced ULL	OM4	Stranded	Method B Enhanced	PPL-SP-24LC-OM4-PT-BEU	760255054
	Propel Multimode Splice Cassette, 24LC/UPC with internal shutters, OM4 ribbon fiber pigtail, Method B Enhanced ULL	OM4	Rollable Ribbon	Method B Enhanced	PPL-SP-24LC-OM4-RPT-BEU	760255057
	Propel Singlemode Splice Cassette, 24LC/UPC with internal shutters, OS2 ribbon fiber pigtail, Method B Enhanced ULL	OS2	Rollable Ribbon	Method B Enhanced	PPL-SP-24LC-SM-RPT-BEU	760255056
	Propel Singlemode Splice Cassette, 12LC/UPC with internal shutters, 250 µm OS2 single fiber pigtails, Method B Enhanced ULL	OS2	Stranded	Method B Enhanced	PPL-SP-12LC-SM-PT-BEU	760255043
	Propel Singlemode Splice Cassette, 12LC/UPC with internal shutters, 250 µm OS2 single fiber pigtails, pairs straight ULL	OS2	Stranded	Pairs Straight	PPL-SP-12LC-SM-PT-AS	760255076
	Propel Singlemode Splice Cassette, 24LC/UPC with internal shutters, OS2 250µm single fiber pigtails, Method B Enhanced ULL	OS2	Stranded	Method B Enhanced	PPL-SP-24LC-SM-PT-BEU	760255053
	Propel Singlemode Splice Cassette, 24LC/UPC with internal shutters, OS2 250µm single fiber pigtails, Method A Straight ULL	OS2	Stranded	Method A Pairs Straight	PPL-SP-24LC-SM-PT-ASU	760255081
19-Inch Cable Management Accessories	Type	Description Code	Part Number			
Small universal blocking kit. Used for on-frame blocking and breakout of Rollable Ribbon cables into 19" Panels	Rollable Ribbon	BK-FP-SML	760238380			
Large universal blocking kit. Used for on-frame blocking and breakout of Rollable Ribbon cables into 19" Panels	Rollable Ribbon	BK-FP-LRG	760238381			

Direct System Selection Index

Splice Closures	Building Entrance Solutions	FACT Optical Distribution Frame	Propel XFrame	19" Splice Solutions	Singlemode Fiber Cables	Pre-term 19" Fiber	Pre-term FACT ODF Fiber	Fiber Optic Patch Cords	FiberGuide	Copper Category 6A	Cable Management & Overhead Racks	FiberREACH
-----------------	-----------------------------	---------------------------------	---------------	----------------------	-------------------------	--------------------	-------------------------	-------------------------	------------	--------------------	-----------------------------------	------------

Architecture System Selection Index

Colocation Campus and Building Infrastructure

Fiber Entrance, Meet-Me Room	High Fiber Count DC Interconnect	Campus Cabling	Building Cabling	Campus Cabling for Wi-Fi and Security
------------------------------	----------------------------------	----------------	------------------	---------------------------------------

Customer Space Cabling Infrastructure

Overview	MDA Fiber	ToR Fiber	EoR Copper	FiberGuide Raceway
----------	-----------	-----------	------------	--------------------

Reference Designs and Technical Information

MDA Cabinet	MDA Cross-connect 19"	MDA Cross-connect FACT ODF	IDF FACT	IDF 19"
-------------	-----------------------	----------------------------	----------	---------



Select a product for more information.

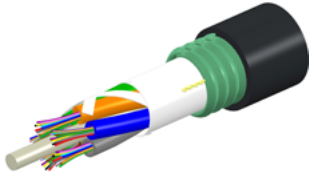

Outdoor Armored Cable

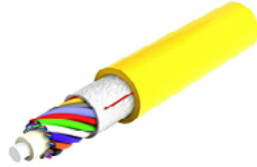

Indoor Stranded Microsheath Cable

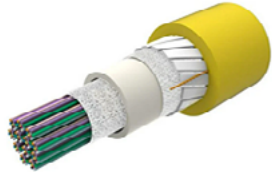

Indoor Rollable Ribbon Central Loose Tube Cable

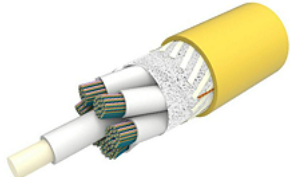

Indoor Rollable Ribbon Loose Tube Cable



Indoor/Outdoor Rollable Ribbon Central Tube Cable, Interlocking Armored



Indoor/Outdoor Rollable Ribbon Loose Tube Cable, Interlocking Armored



Indoor/Outdoor Rollable Ribbon Central Loose Tube Cable

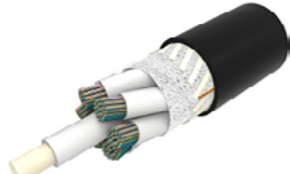

Indoor/Outdoor Rollable Ribbon Loose Tube Cable



Outdoor Rollable Ribbon Stranded Loose Tube Cable, Armored



Outdoor Rollable Ribbon Stranded Loose Tube Cable

Learn more about CommScope's Rollable Ribbon Fiber Solutions here.

Direct System Selection Index

Splice Closures	Building Entrance Solutions	FACT Optical Distribution Frame	Propel XFrame	19" Splice Solutions	Singlemode Fiber Cables	Pre-term 19" Fiber	Pre-term FACT ODF Fiber	Fiber Optic Patch Cords	FiberGuide	Copper Category 6A	Cable Management & Overhead Racks	FiberREACH
-----------------	-----------------------------	---------------------------------	---------------	----------------------	-------------------------	--------------------	-------------------------	-------------------------	------------	--------------------	-----------------------------------	------------

Architecture System Selection Index

Colocation Campus and Building Infrastructure

Fiber Entrance, Meet-Me Room	High Fiber Count DC Interconnect	Campus Cabling	Building Cabling	Campus Cabling for Wi-Fi and Security
------------------------------	----------------------------------	----------------	------------------	---------------------------------------

Customer Space Cabling Infrastructure

Overview	MDA Fiber	ToR Fiber	EoR Copper	FiberGuide Raceway
----------	-----------	-----------	------------	--------------------

Reference Designs and Technical Information

MDA Cabinet	MDA Cross-connect 19"	MDA Cross-connect FACT ODF	IDF FACT	IDF 19"
-------------	-----------------------	----------------------------	----------	---------



Rollable Ribbon Fiber Solutions

Advances in technology have enabled the data center industry to keep ahead of the insatiable demand for more capacity and bandwidth. Faster processors, higher density storage and high-speed, more cost-effective connectivity have been key contributors to this success.

Rollable ribbon fiber technology is one of the latest technology advances that helps data center managers meet demand while maximizing precious space in pathways and ducts. The inherent flexibility of the rollable ribbon matrix allows it to deliver up to twice as many fibers within the same cable diameter as conventional flat ribbon cables while maintaining the installation advantages that ribbon technology offers.

CommScope's rollable ribbon solutions extend well beyond just fiber cable. From the outside plant networks to building entrance, meet-me rooms and even extending to customer cages in multitenant data centers, CommScope offers a comprehensive range of singlemode fiber solutions that fully leverage rollable ribbon fiber technology, offering data center operators faster time to service and better utilization of valuable space in the data center.

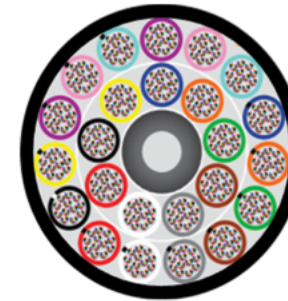
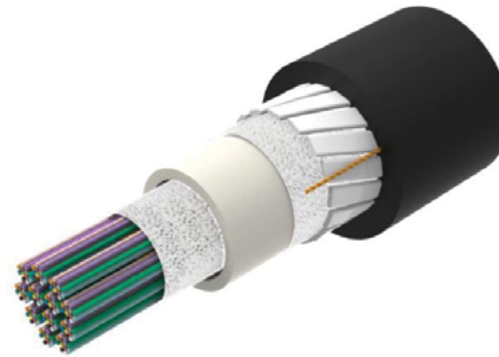

Rollable Ribbon Fiber Cable



Flat Ribbon Fiber Cable

Direct System Selection Index

Splice Closures	Building Entrance Solutions	FACT Optical Distribution Frame	Propel XFrame	19" Splice Solutions	Singlemode Fiber Cables	Pre-term 19" Fiber	Pre-term FACT ODF Fiber	Fiber Optic Patch Cords	FiberGuide	Copper Category 6A	Cable Management & Overhead Racks	FiberREACH
-----------------	-----------------------------	---------------------------------	---------------	----------------------	-------------------------	--------------------	-------------------------	-------------------------	------------	--------------------	-----------------------------------	------------

Architecture System Selection Index

Colocation Campus and Building Infrastructure

Fiber Entrance, Meet-Me Room	High Fiber Count DC Interconnect	Campus Cabling	Building Cabling	Campus Cabling for Wi-Fi and Security
------------------------------	----------------------------------	----------------	------------------	---------------------------------------

Customer Space Cabling Infrastructure

Overview	MDA Fiber	ToR Fiber	EoR Copper	FiberGuide Raceway
----------	-----------	-----------	------------	--------------------

Reference Designs and Technical Information

MDA Cabinet	MDA Cross-connect 19"	MDA Cross-connect FACT ODF	IDF FACT	IDF 19"
-------------	-----------------------	----------------------------	----------	---------



Rollable Ribbon Technology

CommScope's rollable ribbon technology utilizes partially bonded fiber ribbons composed of 12 fibers. Unlike conventional ribbons, which are fully longitudinally bonded, rollable ribbons are partially bonded, which allows them to be easily separated and "rolled" into a cylinder, thus making much better use of space when compared with flat ribbons.

Cables containing rollable ribbon fibers offer significant advantages over flat ribbon fiber cables, including:

- Double the fiber density of standard matrix flat ribbons
- Smaller, lighter cables simplify handling and installation
- Significant reduction in splice time through use of mass fusion splicing
- No preferential bend (a common feature of flat matrix ribbons)
- Easy separation for splicing or connectorization
- Smaller bend radii due to smaller cable diameter, allowing smaller telecom spaces such as closures, panels and hand holes
- Outdoor cables available in gel-free construction
- Fiber counts available from 144 to 3,456

OSP rollable ribbon fiber cables offer double the fiber counts compared with flat ribbon fiber cables, as shown in the table below comparing several duct sizes.

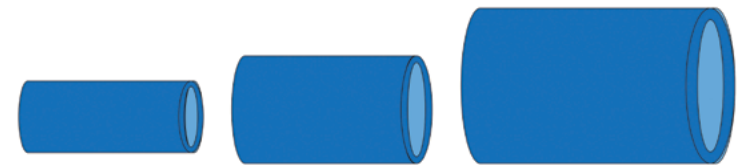

Max Fiber Count	1 in. (2.5 cm) duct	1 1/4 in. (3.2 cm) duct	2 in. (5 cm) duct
Flat Ribbon	432	864	1728
Rollable Ribbon	864	1728	3456

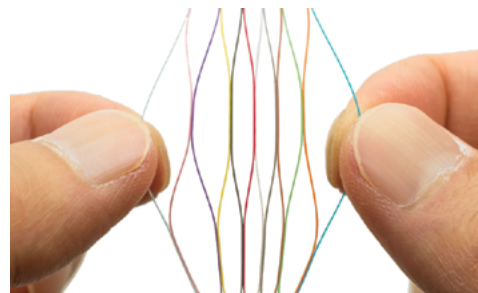

Rollable Ribbon

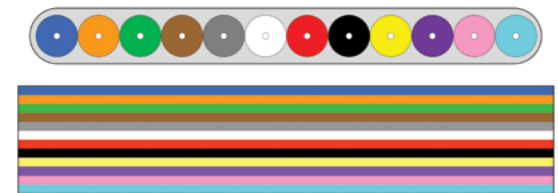

Conventional Flat Ribbon Matrix
(Side View and Top View)

Direct System Selection Index

Splice Closures	Building Entrance Solutions	FACT Optical Distribution Frame	Propel XFrame	19" Splice Solutions	Singlemode Fiber Cables	Pre-term 19" Fiber	Pre-term FACT ODF Fiber	Fiber Optic Patch Cords	FiberGuide	Copper Category 6A	Cable Management & Overhead Racks	FiberREACH
-----------------	-----------------------------	---------------------------------	---------------	----------------------	-------------------------	--------------------	-------------------------	-------------------------	------------	--------------------	-----------------------------------	------------

Architecture System Selection Index

Colocation Campus and Building Infrastructure

Fiber Entrance, Meet-Me Room	High Fiber Count DC Interconnect	Campus Cabling	Building Cabling	Campus Cabling for Wi-Fi and Security
------------------------------	----------------------------------	----------------	------------------	---------------------------------------

Customer Space Cabling Infrastructure

Overview	MDA Fiber	ToR Fiber	EoR Copper	FiberGuide Raceway
----------	-----------	-----------	------------	--------------------

Reference Designs and Technical Information

MDA Cabinet	MDA Cross-connect 19"	MDA Cross-connect FACT ODF	IDF FACT	IDF 19"
-------------	-----------------------	----------------------------	----------	---------



Rollable Ribbon Non-Armored External Fiber Optic Cable	Total Number of Fibers	Fibers Per Sub-Unit	Sheath Material	Outer Diameter	Minimum Bend Radius, Loaded	Description Code	Part Number
Outdoor Non-Armored, All-Dielectric, Gel-Free, Stranded Loose Tube Rollable Ribbon Cable	1728	288	UV Stabilized	0.988 in. (25.1 mm)	14.843 in. (377 mm)	D-1728-LN-RR-F12NS/8W/99H	760239389
Outdoor Non-Armored, All-Dielectric, Gel-Free, Stranded Loose Tube Rollable Ribbon Cable	864	144	UV Stabilized	0.827 in. (21 mm)	12.362 in. (314 mm)	D-864-LN-RR-F12NS/8W/99H	760241354
Rollable Ribbon Armored External Fiber Optic Cable	Total Number of Fibers	Fibers Per Sub-Unit	Sheath Material	Outer Diameter	Minimum Bend Radius, Loaded	Description Code	Part Number
Outdoor Steel Armored, Gel-Free, Stranded Loose Tube Rollable Ribbon Cable	1728	288	UV Stabilized	1.055 in. (26.8 mm)	15.787 in. (401 mm)	D-1728-LA-RR-F12NS/8W/99H	760239858
Outdoor Steel Armored, Gel-Free, Stranded Loose Tube Rollable Ribbon Cable	864	144	UV Stabilized	0.913 in. (23.2 mm)	13.701 in. (348 mm)	D-864-LA-RR-F12NS/8W/99H	760241358
Rollable Ribbon Non-Armored Indoor / Outdoor Armored External Fiber Optic Cable	Total Number of Fibers	Fibers Per Sub-Unit	Sheath Material	Outer Diameter	Minimum Bend Radius, Loaded	Description Code	Part Number
Outdoor/Indoor LSZH Rollable Ribbon Cable with 200um Fibers	3456	576	LSZH Cca	1.083 in. (27.5 mm)		Z-3456-LN-RR-F12BK/8G1/99L/200/C	760250982
Indoor/Outdoor, All-Dielectric, Low Smoke Zero Halogen (LSZH), Riser-Rated, Gel-Free, Loose Tube Rollable Ribbon Cable	1728	288	LSZH B2ca	1 in. (25.4 mm)	20 in. (508 mm)	Z-1728-LN-RR-F12BK/8G1/99H/B2	760244183
Indoor/Outdoor, All-Dielectric, Low Smoke Zero Halogen (LSZH), Riser-Rated, Gel-Free, Central Tube Rollable Ribbon Cable	864	Single Central Tube	LSZH Cca	0.768 in. (19.5 mm)	15.354 in. (390 mm)	Z-864-CN-RR-F12BK/8G/99G/C	760239025
Rollable Ribbon Armored Indoor / Outdoor Armored External Fiber Optic Cable	Total Number of Fibers	Fibers Per Sub-Unit	Sheath Material	Outer Diameter	Minimum Bend Radius, Loaded	Description Code	Part Number
Indoor/Outdoor, Riser-Rated, Gel-Free, Inner Low Smoke Zero Halogen (LSZH) Stranded Loose Tube Rollable Ribbon Cable with Aluminum Interlocking Armor and a LSZH Outer Jacket	1728	288	LSZH B2ca	1.354 in. (34.4 mm)	20.315 in. (516 mm)	Z-1728-LZ-RR-F12BK/8G1/99H/B2	760245915
Indoor/Outdoor, Interlocking Armored, Low Smoke Zero Halogen (LSZH), Riser-Rated, Gel-Free, Central Tube Rollable Ribbon Cable	864	Single Central Tube	LSZH B2ca	1.106 in. (28.1 mm)	22.126 in. (562 mm)	Z-864-CZ-RR-F12BK/8G/99G/B2	760239052
Rollable Ribbon Non-Armored Indoor Fiber Optic Cable	Total Number of Fibers	Fibers Per Sub-Unit	Sheath Material	Outer Diameter	Minimum Bend Radius, Loaded	Description Code	Part Number
Indoor, All-Dielectric, Low Smoke Zero Halogen (LSZH), Riser-Rated, Gel-Free, Loose Tube Rollable Ribbon Cable	1728	288	LSZH B2ca	1 in. (25.4 mm)	20 in. (508 mm)	N-1728-LN-RR-F12YL/8G/99H/B2	760244182
Indoor, All-Dielectric, Low Smoke Zero Halogen (LSZH), Riser-Rated, Gel-Free, Central Tube Rollable Ribbon Cable	864	Single Central Tube	LSZH Cca	0.768 in. (19.5 mm)	15.354 in. (390 mm)	N-864-CN-RR-F12YL/8G1/99G/C	760242275
Indoor, All-Dielectric, Low Smoke Zero Halogen (LSZH), Riser-Rated, Gel-Free, Central Tube Rollable Ribbon Cable	288	Single Central Tube	LSZH Cca	0.492 in. (12.5 mm)	9.843 in. (250 mm)	N-288-CN-RR-F12YL/8G1/99G/C	760239308
Indoor All-Dielectric, Low Smoke Zero Halogen (LSZH), Riser-Rated, Gel-Free, Central Tube Rollable Ribbon Cable	144	Single Central Tube	LSZH Cca	0.413 in. (10.5 mm)	8.268 in. (210 mm)	N-144-CN-RR-F12YL/8G1/99G/C	760239307

Direct System Selection Index

Splice Closures	Building Entrance Solutions	FACT Optical Distribution Frame	Propel XFrame	19" Splice Solutions	Singlemode Fiber Cables	Pre-term 19" Fiber	Pre-term FACT ODF Fiber	Fiber Optic Patch Cords	FiberGuide	Copper Category 6A	Cable Management & Overhead Racks	FiberREACH
-----------------	-----------------------------	---------------------------------	---------------	----------------------	-------------------------	--------------------	-------------------------	-------------------------	------------	--------------------	-----------------------------------	------------

Architecture System Selection Index

Colocation Campus and Building Infrastructure

Fiber Entrance, Meet-Me Room	High Fiber Count DC Interconnect	Campus Cabling	Building Cabling	Campus Cabling for Wi-Fi and Security
------------------------------	----------------------------------	----------------	------------------	---------------------------------------

Customer Space Cabling Infrastructure

Overview	MDA Fiber	ToR Fiber	EoR Copper	FiberGuide Raceway
----------	-----------	-----------	------------	--------------------

Reference Designs and Technical Information

MDA Cabinet	MDA Cross-connect 19"	MDA Cross-connect FACT ODF	IDF FACT	IDF 19"
-------------	-----------------------	----------------------------	----------	---------



Stranded Non-Armored Microsheath Indoor Fiber Optic Cable	Total Number of Fibers	Fibers Per Sub-Unit	Sheath Material	Outer Diameter	Minimum Bend Radius, Loaded	Description Code	Part Number
Single Jacket All-Dielectric, Gel-Free, Indoor Stranded Microsheath Tube Cable OS2, 144f, Cca	144	12	LSZH Cca	10.2 mm	200 mm	L-144-LN-8F-M12YL/14D/GY/C	760243186
Single Jacket All-Dielectric, Gel-Free, Indoor Stranded Microsheath Tube Cable OS2 144f, B2ca	144	12	LSZH B2ca	10.7 mm	130 mm	C-144-LN-8W-M12BK/15D/B2	760256144
Single Jacket All-Dielectric, Gel-Free, Indoor Stranded Microsheath Tube Cable OS2 96f, Cca	96	12	LSZH Cca	8.4 mm	170 mm	L-096-LN-8F-M12YL/14D/GY/C	760245018
Single Jacket All-Dielectric, Gel-Free, Indoor Stranded Microsheath Tube Cable OS2 96f, B2ca	96	12	LSZH B2ca	8.7 mm	110 mm	C-096-LN-8W-M12BK/15D/B2	760256143
Single Jacket All-Dielectric, Gel-Free, Indoor Stranded Microsheath Tube Cable OS2 48f, Cca	48	12	LSZH Cca	6.6 mm	130 mm	L-048-LN-8F-M12YL/14D/GY/C	760245020
Single Jacket All-Dielectric, Gel-Free, Indoor Stranded Microsheath Tube Cable OS2 48f, B2ca	48	12	LSZH B2ca	6.7 mm	150 mm	C-048-LN-8W-M12BK/15D/B2	760256141
Single Jacket All-Dielectric, Gel-Free, Indoor Stranded Microsheath Tube Cable OS2 24f, Cca	24	12	LSZH Cca	6.6 mm	130 mm	L-024-LN-8F-M12YL/14D/GY/C	760245021
Single Jacket All-Dielectric, Gel-Free, Indoor Stranded Microsheath Tube Cable OS2 24f, B2ca	24	12	LSZH B2ca	6.7 mm	150 mm	C-024-LN-8W-M12BK/15D/B2	760256139
Distribution Non-Armored Indoor Fiber Optic Cable	Total Number of Fibers	Fibers Per Sub-Unit	Sheath Material	Outer Diameter	Minimum Bend Radius, Loaded	Description Code	Part Number
TeraSPEED® Low Smoke Zero Halogen Riser, 48 fiber multi-unit with 12 fiber subunits	48	12	LSZH Cca	0.637 in. (16.19 mm)	9.567 in. (243 mm)	N-048-DS-8W-FMUYL/C	760004291
TeraSPEED Low Smoke Zero Halogen Riser, 24 fiber single-unit, singlemode	24	N/A	LSZH B2ca	0.347 in. (8.82 mm)	5.197 in. (132 mm)	N-024-DS-8W-FSUYL/B2	760241765
TeraSPEED Low Smoke Zero Halogen Riser, 12 fiber single-unit, singlemode	12	N/A	LSZH B2ca	0.240 in. (6.1 mm)	3.622 in. (92 mm)	N-012-DS-8W-FSUYL/B2	760248874
Loose Tube Cable Outdoor, Armored	Fiber Type	Fiber Count	Jacket Material	Description Code	Part Number		
Singlemode OS2 Single Jacket/Single Armor, Gel-Free, Outdoor Stranded Loose Tube Cable, 48 fibers	OS2	48	PE	D-048-LA-8W-F12NS	760053314		
Singlemode OS2 Single Jacket/Single Armor, Gel-Free, Outdoor Stranded Loose Tube Cable, 96 fibers	OS2	96	PE	D-096-LA-8W-F12NS	760053348		
Singlemode OS2 Single Jacket/Single Armor, Gel-Free, Outdoor Stranded Loose Tube Cable, 144 fibers	OS2	144	PE	D-144-LA-8W-F12NS	760053355		
Singlemode OS2 Single Jacket/Single Armor, Gel-Free, Outdoor Stranded Loose Tube Cable, 288 fibers	OS2	288	PE	D-288-LA-8W-F12NS	760053363		

Direct System Selection Index

Splice Closures	Building Entrance Solutions	FACT Optical Distribution Frame	Propel XFrame	19" Splice Solutions	Singlemode Fiber Cables	Pre-term 19" Fiber	Pre-term FACT ODF Fiber	Fiber Optic Patch Cords	FiberGuide	Copper Category 6A	Cable Management & Overhead Racks	FiberREACH
---------------------------------	---	---	-------------------------------	--------------------------------------	---	------------------------------------	---	---	----------------------------	------------------------------------	---	----------------------------

Architecture System Selection Index

Colocation Campus and Building Infrastructure

Fiber Entrance, Meet-Me Room	High Fiber Count DC Interconnect	Campus Cabling	Building Cabling	Campus Cabling for Wi-Fi and Security
--	--	--------------------------------	----------------------------------	---

Customer Space Cabling Infrastructure

Overview	MDA Fiber	ToR Fiber	EoR Copper	FiberGuide Raceway
--------------------------	---------------------------	---------------------------	----------------------------	------------------------------------

Reference Designs and Technical Information

MDA Cabinet	MDA Cross-connect 19"	MDA Cross-connect FACT ODF	IDF FACT	IDF 19"
-----------------------------	---------------------------------------	--	--------------------------	-------------------------



Pre-terminated Fiber Systems

Pre-terminated 19" Fiber System Solutions

Pre-terminated FACT ODF Fiber System Solutions



EPX
48 ports LC-D or 32 ports MPO
No cable management
Basic labeling

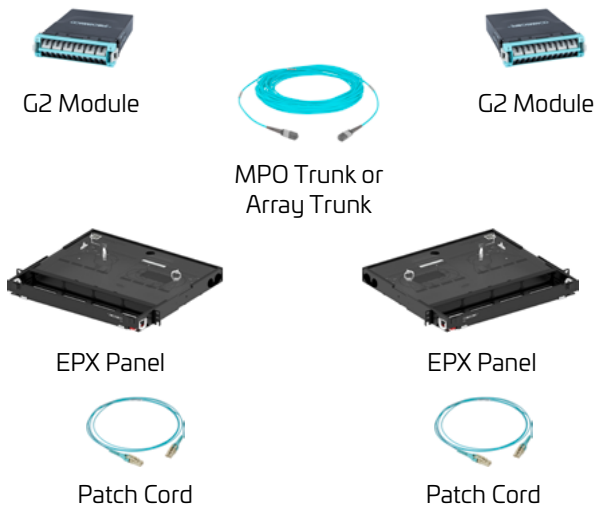

Propel
72 ports MPO or 144 ports SN or 72 ports LC-D
Front cable management
Labeling option (printer support)
Sliding tray for better cable modules access
Panels available in 1, 2 and 4RU

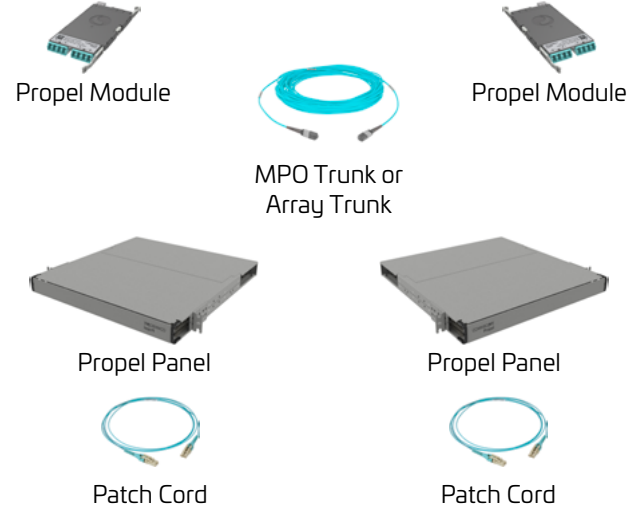

Evolve Mixed Media
For mixed copper and fiber installations
Fiber 48 ports LC-D or 32 ports MPO; Copper: 24 RJ45 ports
No cable management
Basic labeling
Panels available in 1RU

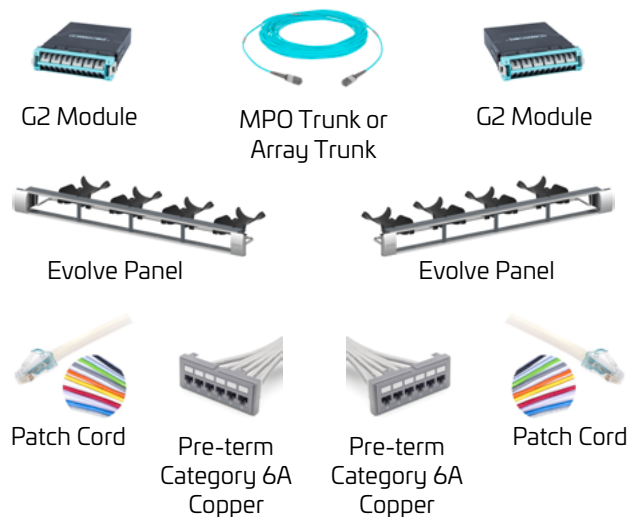

Direct System Selection Index

Splice Closures	Building Entrance Solutions	FACT Optical Distribution Frame	Propel XFrame	19" Splice Solutions	Singlemode Fiber Cables	Pre-term 19" Fiber	Pre-term FACT ODF Fiber	Fiber Optic Patch Cords	FiberGuide	Copper Category 6A	Cable Management & Overhead Racks	FiberREACH
-----------------	-----------------------------	---------------------------------	---------------	----------------------	-------------------------	--------------------	-------------------------	-------------------------	------------	--------------------	-----------------------------------	------------

Architecture System Selection Index

Colocation Campus and Building Infrastructure

Fiber Entrance, Meet-Me Room	High Fiber Count DC Interconnect	Campus Cabling	Building Cabling	Campus Cabling for Wi-Fi and Security
------------------------------	----------------------------------	----------------	------------------	---------------------------------------

Customer Space Cabling Infrastructure

Overview	MDA Fiber	ToR Fiber	EoR Copper	FiberGuide Raceway
----------	-----------	-----------	------------	--------------------

Reference Designs and Technical Information







MDA Cabinet	MDA Cross-connect 19"	MDA Cross-connect FACT ODF	IDF FACT	IDF 19"
-------------	-----------------------	----------------------------	----------	---------



Review Pre-terminated 19" Fiber System Selection here.

EPX
Evolve Mixed Media

Fits to	EPX Fiber Panel	See lower menu bar for use cases				RU	Description Code	Part Number
	EPX 1U open fixed panel, accepts (4) G2 style splice cassettes, modules or adapter packs, providing up to 48 duplex LC ports					1	EPX-1U-MOD-OPEN-FX	760251098
	EPX 1U sliding panel, accepts (4) G2 style splice cassettes, modules or adapter packs, providing up to 48 duplex LC ports					1	EPX-1U-MOD-ENC	760249998

Fits to	Evolve Mixed Media Panels	Fits to Reference Designs				Copper Tech	Description Code	Part Number
	SYSTIMAX GigaSPEED® X10D® and GigaSPEED XL® Evolve 1U U/UTP Panel Kit	 				U/UTP	360-E-KIT-1U	760155739
	SYSTIMAX GigaSPEED X10D Evolve 1U F/UTP Panel Kit	 				F/UTP	360-IPR-MFTP-E-HD6B-1U-24	760150144
Fits to	Evolve Mixed Media Panels Accessories						Description Code	Part Number
	SYSTIMAX 360 1100 Evolve G2 BEZEL (Cool Gray)						360-1100-E-FB-4PK	760175877
	SYSTIMAX 360 1100 Evolve Fiber Cable Management						361 1100-E-FCM	760175919
	SYSTIMAX 360 1100 Evolve G2 BEZEL (Blank)						360-1100-E-BB	760165191

Fits to	G2 Fiber Modules/Adapter Packs			Connector	Fiber	Module	Description Code	Part Number
	G2 ULL MPO-12 distribution module, 24LC to 2x12f MPO unpinned, OM5 Wideband, internal shutter			MPO12	OM5	Distribution	DM12-24LC-WB-UULL	760236111
	G2 ULL MPO-12 distribution module, 24LC to 2x12f MPO unpinned, OM4 internal shutter			MPO12	OM4	Distribution	DM12-24LC-LS-UULL	760236110
	G2 ULL 2x3 LazrSPEED® OM4 Conversion Module, (2) MPO-12 unpinned ports rear, (3) MPO-8 pinned front			MPO12	OM4	Conversion	CM12-2x3-LS-UULL	760237217
	G2 ULL 2x3 LazrSPEED OM5 Conversion Module, (2) MPO-12 unpinned ports rear, (3) MPO-8 pinned front			MPO12	OM5	Conversion	CM12-2x3-WB-UULL	760237218
	G2 ULL MPO-12 distribution module, 24LC to 2x12f MPOs unpinned, singlemode internal shutter			MPO12	OS2	Distribution	DM12-24LC-SM-UULL	760238083
	G2 ULL 2x3 Singlemode Conversion Module, (2) MPO-12 unpinned ports rear, (3) MPO-8 pinned front			MPO12	OS2	Conversion	CM12-2X3-SM-UULL	760237216
	G2 Distribution Adapter Pack, 360DP-8MPO, 8 x MPO			N/A	Universal	MPO Adapter Pack	360DP-8MPO	760107524
	G2 Distribution Adapter Pack 24 LC with internal shutters, Multimode OM4 Aqua			N/A	OM4	LC Adapter Pack	360DPis-24LC-LS	760216754
	G2 Distribution Adapter Pack 24 LC with internal shutters, Multimode OM5 Lime Green			N/A	OM5	LC Adapter Pack	360DPis-24LC-WB	760236041
	G2 Distribution Adapter Pack 24 LC with internal shutters, Singlemode Blue			N/A	OS2	LC Adapter Pack	360DPis-24LC-SM	760216762
G2 blank adapters, 4 pcs			N/A	N/A	Blank Panel	360G2-MOD-BLANK-4PK	760109462	

Direct System Selection Index

Splice Closures	Building Entrance Solutions	FACT Optical Distribution Frame	Propel XFrame	19" Splice Solutions	Singlemode Fiber Cables	Pre-term 19" Fiber	Pre-term FACT ODF Fiber	Fiber Optic Patch Cords	FiberGuide	Copper Category 6A	Cable Management & Overhead Racks	FiberREACH
---------------------------------	---	---	-------------------------------	--------------------------------------	---	------------------------------------	---	---	----------------------------	------------------------------------	---	----------------------------

Architecture System Selection Index

Colocation Campus and Building Infrastructure

Fiber Entrance, Meet-Me Room	High Fiber Count DC Interconnect	Campus Cabling	Building Cabling	Campus Cabling for Wi-Fi and Security
--	--	--------------------------------	----------------------------------	---

Customer Space Cabling Infrastructure

XC Fiber	ToR Fiber	EoR Copper	FiberGuide Raceway
--------------------------	---------------------------	----------------------------	------------------------------------

Reference Designs and Technical Information

MDA Cabinet	MDA Cross-connect 19"	MDA Cross-connect FACT ODF	IDF FACT	IDF 19"
-----------------------------	---------------------------------------	--	--------------------------	-------------------------



Review Pre-terminated 19" Fiber System Selection [here](#).

Propel

Fits to	Propel Fiber Panels - Sliding	Fits to Reference Designs	U Height	Description Code	Part Number
■	Propel 1RU sliding tray fiber panel, accepts Propel ULL modules or adapter packs, providing up to 72 duplex LC ports, 72 MPO ports or 144 SN ports (288f)		1	PPL-1U	760252002
	Propel 2RU sliding tray fiber panel, accepts Propel ULL modules or adapter packs, providing up to 144 duplex LC ports, 144 MPO ports or 288 SN ports (576f)		2	PPL-2U	760252003
	Propel 4RU sliding tray fiber panel, accepts Propel ULL modules or adapter packs, providing up to 288 duplex LC ports, 288 MPO ports or 576 SN ports (1152f)		4	PPL-4U	760252004
Fits to	Propel Fiber Panels - Fixed	Fits to Reference Designs	U Height	Description Code	Part Number
■	Propel 1RU fixed tray fiber panel, accepts Propel components, providing up to 48 duplex LC ports, 48 MPO ports or 96 SN ports (192f)		1	PPL-1U-HD-FX	760253796
	Propel 2RU fixed tray fiber panel, accepts Propel ULL modules or adapter packs, providing up to 96 duplex LC ports, 96 MPO ports or 192 SN ports (384f)		2	PPL-2U-HD-FX	760253797
	Propel 4RU fixed tray fiber panel, accepts Propel ULL modules or adapter packs, providing up to 192 duplex LC ports, 192 MPO ports or 384 SN ports (768f)		4	PPL-4U-HD-FX	760253798
Fits to	Propel Fiber Panels - Fixed, Open Rear	Fits to Reference Designs	U Height	Description Code	Part Number
■	Propel 1RU fixed tray open fiber panel, accepts Propel components, providing up to 48 duplex LC ports, 48 MPO ports or 96 SN ports (192f)		1	PPL-1U-HD-FX-OPEN	760254865
	Propel 2RU fixed tray open fiber panel, accepts Propel components, providing up to 96 duplex LC ports, 96 MPO ports or 192 SN ports (384f)		2	PPL-2U-HD-FX-OPEN	760254908

Fits to	Propel Cabled Modules	Connector	Fiber Type	Form Factor	Description Code
■	Propel ULL Multimode OM4 Cabled Module, 1x8 duplex LC Propel module on End A to 1x8f MPO/UPC non-pinned on End B, 8 fiber B2ca Trunk, Method B Enhanced	MPO-8	OM4	Cabled Module	PPLU3X8LCQP8
	Propel ULL Multimode OM4 Cabled Module, 1x8 duplex LC Propel module on End A to 1x8f MPO/UPC pinned on End B, 8 fiber B2ca Trunk, Method B Enhanced	MPO-8	OM4	Cabled Module	PPLU3X8LCQX8
	Propel ULL Singlemode Cabled Module, 1x8 duplex LC Propel module on End A to 1x8f MPO/UPC non-pinned on End B, 8 fiber B2ca Trunk, Method B Enhanced	MPO-8	OS2	Cabled Module	PPLU3G8LCQP8
	Propel ULL Singlemode Cabled Module, 1x8 duplex LC Propel module on End A to 1x8f MPO/UPC pinned on End B, 8 fiber B2ca Trunk, Method B Enhanced	MPO-8	OS2	Cabled Module	PPLU3G8LCQX8
	Propel ULL Multimode OM4 Cabled Module, 1x12 duplex LC Propel module on End A to 1x12f MPO/UPC non-pinned on End B, 12 fiber B2ca Trunk, Method B Enhanced	MPO-12	OM4	Cabled Module	PPLU3X12LCMPD
	Propel ULL Multimode OM4 Cabled Module, 1x12 duplex LC Propel module on End A to 1x12f MPO/UPC pinned on End B, 12 fiber B2ca Trunk, Method B Enhanced	MPO-12	OM4	Cabled Module	PPLU3X12LCMXD
	Propel ULL Singlemode Cabled Module, 1x12 duplex LC Propel module on End A to 1x12f MPO/UPC non-pinned on End B, 12 fiber B2ca Trunk, Method B Enhanced	MPO-12	OS2	Cabled Module	PPLU3G12LCMPD
	Propel ULL Singlemode Cabled Module, 1x12 duplex LC Propel module on End A to 1x12f MPO/UPC pinned on End B, 12 fiber B2ca Trunk, Method B Enhanced	MPO-12	OS2	Cabled Module	PPLU3G12LCMXD
	Propel ULL Multimode OM4 Cabled Module, 1x16 duplex LC Propel module on End A to 1x16f MPO/APC non-pinned Multimode on End B, 16 fiber B2ca Trunk, Method B Enhanced	MPO-16	OM4	Cabled Module	PPLU3X16LCRVR
	Propel ULL Multimode OM4 Cabled Module, 1x16 duplex LC Propel module on End A to 1x16f MPO/APC pinned Multimode on End B, 16 fiber B2ca Trunk, Method B Enhanced	MPO-16	OM4	Cabled Module	PPLU3X16LCRZR
	Propel ULL Singlemode Cabled Module, 1x16 duplex LC Propel module on End A to 1x16f MPO/APC non-pinned Singlemode on End B, 16 fiber B2ca Trunk, Method B Enhanced	MPO-16	OS2	Cabled Module	PPLU3G16LCRPR
	Propel ULL Singlemode Cabled Module, 1x16 duplex LC Propel module on End A to 1x16f MPO/APC pinned Singlemode on End B, 16 fiber B2ca Trunk, Method B Enhanced	MPO-16	OS2	Cabled Module	PPLU3G16LCRXR

Direct System Selection Index

Splice Closures	Building Entrance Solutions	FACT Optical Distribution Frame	Propel XFrame	19" Splice Solutions	Singlemode Fiber Cables	Pre-term 19" Fiber	Pre-term FACT ODF Fiber	Fiber Optic Patch Cords	FiberGuide	Copper Category 6A	Cable Management & Overhead Racks	FiberREACH
---------------------------------	---	---	-------------------------------	--------------------------------------	---	------------------------------------	---	---	----------------------------	------------------------------------	---	----------------------------

Architecture System Selection Index

Colocation Campus and Building Infrastructure

Fiber Entrance, Meet-Me Room	High Fiber Count DC Interconnect	Campus Cabling	Building Cabling	Campus Cabling for Wi-Fi and Security
--	--	--------------------------------	----------------------------------	---

Customer Space Cabling Infrastructure

XC Fiber	ToR Fiber	EoR Copper	FiberGuide Raceway
--------------------------	---------------------------	----------------------------	------------------------------------

Reference Designs and Technical Information

MDA Cabinet	MDA Cross-connect 19"	MDA Cross-connect FACT ODF	IDF FACT	IDF 19"
-----------------------------	---------------------------------------	--	--------------------------	-------------------------



Review Pre-terminated 19" Fiber System Selection here.

Propel

Fits to	Propel Modules and Adapter Packs	Connector	Fiber Type	Form Factor	Description Code	Part Number
	Propel pass-through adapter pack, multimode OM4, 4 duplex LC ports	LC	OM4	Adapter Pack	PPL-AP-8-LC-OM4	760252360
	Propel pass-through adapter pack, singlemode, 4 duplex LC/UPC ports	LC	OS2	Adapter Pack	PPL-AP-8-LC-SM	760252359
	Propel pass-through adapter pack, multimode OM4, 6 duplex LC ports	LC	OM4	Adapter Pack	PPL-AP-12-LC-OM4	760252363
	Propel pass-through adapter pack, singlemode, 6 duplex LC/UPC ports	LC	OS2	Adapter Pack	PPL-AP-12-LC-SM	760252362
	Propel pass-through adapter pack, multimode OM4, 8 duplex LC ports	LC	OM4	Adapter Pack	PPL-AP-16-LC-OM4	760252366
	Propel pass-through adapter pack, singlemode, 8 duplex LC/UPC ports	LC	OS2	Adapter Pack	PPL-AP-16-LC-SM	760252365
	Propel pass-through adapter pack, 4 MPO8-12-24 ports, Type B	4x MPO-8/-12/-24	Universal	Adapter Pack	PPL-AP-4-MPO-ALL-B	760252371
	Propel pass-through adapter pack, 8 MPO8-12-24 ports, Type B	8x MPO-8/-12/-24	Universal	Adapter Pack	PPL-AP-8-MPO-ALL-B	760252373
	Propel pass-through adapter pack, 12 MPO ports, Type B	12x MPO-8/-12/-24	Universal	Adapter Pack	PPL-AP-12-MPO-ALL-B	760252374
	Propel pass-through adapter pack, 4 MPO16 ports, Type B	4x MPO-16	Universal	Adapter Pack	PPL-AP-4-MPO16-ALL-B	760252806
	Propel pass-through adapter pack, 8 MPO16 ports, Type B	8x MPO-16	Universal	Adapter Pack	PPL-AP-8-MPO16-ALL-B	760252804
	Propel ULL Multimode OM4 MPO-08 Distribution Module, 4 duplex LC to 1X8f MPO/UPC non-pinned, Method B Enhanced	MPO-8	OM4	Distribution Module	PPL-DM-8U-8LC-OM4-BEU	760252332
	Propel ULL Multimode OM4 MPO-08 Distribution Module, 4 duplex LC to 1X8f MPO/APC non-pinned, Method B Enhanced	MPO-8	OM4	Distribution Module	PPL-DM-8AU-8LC-OM4-BEU	760252335
	Propel ULL Singlemode MPO-08 Distribution Module, 4 duplex LC/UPC to 1X8f MPO/APC non-pinned, Method B Enhanced	MPO-8	OS2	Distribution Module	PPL-DM-8AU-8LC-SM-BEU	760252334
	Propel ULL Multimode OM4 MPO-12 Distribution Module, 6 duplex LC to 1X12f MPO/UPC non-pinned, Method B Enhanced	MPO-12	OM4	Distribution Module	PPL-DM-12U-12LC-OM4-BEU	760252343
	Propel ULL Multimode OM4 MPO-12 Distribution Module, 12 duplex LC to 2X12f MPO/UPC non-pinned, Method B Enhanced	MPO-12	OM4	Distribution Module	PPL-DM-12U-24LC-OM4-BEU	760252346
	Propel ULL Singlemode MPO-12 Distribution Module, 6 duplex LC/UPC to 1X12f MPO/APC non-pinned, Method B Enhanced	MPO-12	OS2	Distribution Module	PPL-DM-12AU-12LC-SM-BEU	760252345
	Propel ULL Singlemode MPO-12 Distribution Module, 12 duplex LC/UPC to 2X12f MPO/APC non-pinned, Method B Enhanced	MPO-12	OS2	Distribution Module	PPL-DM-12AU-24LC-SM-BEU	760252348
	Propel ULL Singlemode MPO-16 Distribution Module, 8 duplex LC/UPC to 1X16f MPO/APC non-pinned, Method B Enhanced	MPO-16	OS2	Distribution Module	PPL-DM-16AU-16LC-SM-BEU	760252352
	Propel ULL Multimode OM4 MPO-16 Distribution Module, 8 duplex LC to 1X16f MPO/APC non-pinned, Method B Enhanced	MPO-16	OM4	Distribution Module	PPL-DM-16AU-16LC-OM4-BEU	760252353

Direct System Selection Index

Splice Closures	Building Entrance Solutions	FACT Optical Distribution Frame	Propel XFrame	19" Splice Solutions	Singlemode Fiber Cables	Pre-term 19" Fiber	Pre-term FACT ODF Fiber	Fiber Optic Patch Cords	FiberGuide	Copper Category 6A	Cable Management & Overhead Racks	FiberREACH
---------------------------------	---	---	-------------------------------	--------------------------------------	---	------------------------------------	---	---	----------------------------	------------------------------------	---	----------------------------

Architecture System Selection Index

Colocation Campus and Building Infrastructure

Fiber Entrance, Meet-Me Room	High Fiber Count DC Interconnect	Campus Cabling	Building Cabling	Campus Cabling for Wi-Fi and Security
--	--	--------------------------------	----------------------------------	---

Customer Space Cabling Infrastructure

Overview	MDA Fiber	ToR Fiber	EoR Copper	FiberGuide Raceway
--------------------------	---------------------------	---------------------------	----------------------------	------------------------------------

Reference Designs and Technical Information

MDA Cabinet	MDA Cross-connect 19"	MDA Cross-connect FACT ODF	IDF FACT	IDF 19"
-----------------------------	---------------------------------------	--	--------------------------	-------------------------



Review Pre-terminated 19" Fiber System Selection here.

All cable assemblies on this page fit to:

Propel

EPX

Evolve Mixed Media

Propel MPO-8 Singlemode & Multimode Trunk Cables

Propel	1 U	2 3	3 X	4 Q	5 X	6 Q	7 X	8 T	9 8	10 -	11 M	12 J	13 F	14-16 003
Construction type U Ultra-low loss	Cable family 3 Trunk, LSZH CPR B2ca J Trunk, Dual Rated (OFNR/LSZH)	Fiber type G Singlemode (A2) X OM4 multimode V OM5 WB multimode	Connector 1 QX 8f MPO UPC (Pinned) QZ 8f MPO APC (Pinned)	Connector 2 QX 8f MPO UPC (Pinned) QZ 8f MPO APC (Pinned)	Cordage size T 8f PMP Trunk, 2.00 mm SU	Fiber count 8 8-fiber R 16-fiber F 24-fiber S 32-fiber H 48-fiber U 64-fiber K 72-fiber L 96-fiber M 144-fiber N 192-fiber	Color M OM4 Aqua N OM5 Lime green J Yellow	Breakout length J 22" Break Propel No Pull Grip K 22" Break Propel Pull Grip A 33" Break EPX/Mixed Media No Gland/No Pulling Grip B 33" Break EPX/Mixed Media With Gland/No Pulling Grip C 33" Break EPX/Mixed Media With Gland/Pulling Grip W 60" Break FACT To FACT 7 22" to 60" Propel to FACT/XFrame with pulling grip	UOM F Feet M Meter	Length 010-999 ft 003-305 m				

Propel MPO-12 Singlemode & Multimode Trunk Cables

Propel	EPX	Evolve Mixed Media	1 U	2 3	3 X	4 M	5 X	6 M	7 X	8 C	9 D	10 -	11 M	12 J	13 F	14-16 003
Construction type U Ultra-low loss	Cable family 3 Trunk, LSZH CPR B2ca J Trunk, Dual Rated (OFNR/LSZH)	Fiber type G Singlemode (A2) X OM4 multimode V OM5 WB multimode	Connector 1 MX 12f MPO (Pinned)	Connector 2 MX 12f MPO (Pinned)	Cordage size C 12f PMP Trunk, 2.00 mm SU	Fiber count D 12-fiber F 24-fiber G 36-fiber H 48-fiber K 72-fiber L 96-fiber M 144-fiber N 192-fiber P 288-fiber	Color M OM4 Aqua N OM5 Lime green J Yellow	Breakout length J 22" Break Propel No Pull Grip K 22" Break Propel Pull Grip A 33" Break EPX/Mixed Media No Gland/No Pulling Grip B 33" Break EPX/Mixed Media With Gland/No Pulling Grip C 33" Break EPX/Mixed Media With Gland/Pulling Grip 2 33" to 60" Break EPX/Mixed Media To FACT/XFrame with Gland/No Pulling Grip 3 33" to 60" Break EPX/Mixed Media To FACT/XFrame with Gland/Pulling Grip W 60" Break FACT/XFrame to FACT/XFrame 7 22" to 60" Propel to FACT/XFrame with pulling grip	UOM F Feet M Meter	Length 010-999 ft 003-305 m						

Direct System Selection Index

Splice Closures	Building Entrance Solutions	FACT Optical Distribution Frame	Propel XFrame	19" Splice Solutions	Singlemode Fiber Cables	Pre-term 19" Fiber	Pre-term FACT ODF Fiber	Fiber Optic Patch Cords	FiberGuide	Copper Category 6A	Cable Management & Overhead Racks	FiberREACH
-----------------	-----------------------------	---------------------------------	---------------	----------------------	-------------------------	--------------------	-------------------------	-------------------------	------------	--------------------	-----------------------------------	------------

Architecture System Selection Index

Colocation Campus and Building Infrastructure

Fiber Entrance, Meet-Me Room	High Fiber Count DC Interconnect	Campus Cabling	Building Cabling	Campus Cabling for Wi-Fi and Security
------------------------------	----------------------------------	----------------	------------------	---------------------------------------

Customer Space Cabling Infrastructure

Overview	MDA Fiber	ToR Fiber	EoR Copper	FiberGuide Raceway
----------	-----------	-----------	------------	--------------------

Reference Designs and Technical Information

MDA Cabinet	MDA Cross-connect 19"	MDA Cross-connect FACT ODF	IDF FACT	IDF 19"
-------------	-----------------------	----------------------------	----------	---------



Review Pre-terminated 19" Fiber System Selection here.

All cable assemblies on this page fit to: **Propel**

Propel MPO-16 (APC) Singlemode & Multimode Trunk Cables

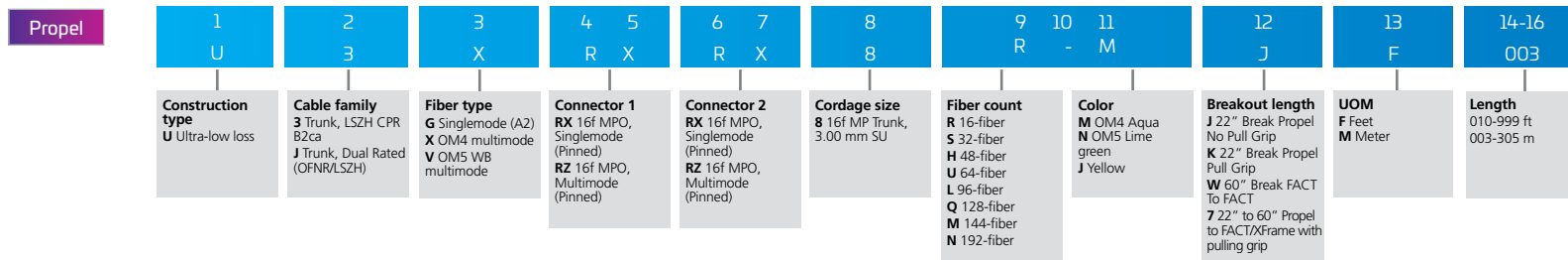

Direct System Selection Index

Splice Closures	Building Entrance Solutions	FACT Optical Distribution Frame	Propel XFrame	19" Splice Solutions	Singlemode Fiber Cables	Pre-term 19" Fiber	Pre-term FACT ODF Fiber	Fiber Optic Patch Cords	FiberGuide	Copper Category 6A	Cable Management & Overhead Racks	FiberREACH
-----------------	-----------------------------	---------------------------------	---------------	----------------------	-------------------------	--------------------	-------------------------	-------------------------	------------	--------------------	-----------------------------------	------------

Architecture System Selection Index

Colocation Campus and Building Infrastructure

Fiber Entrance, Meet-Me Room	High Fiber Count DC Interconnect	Campus Cabling	Building Cabling	Campus Cabling for Wi-Fi and Security
------------------------------	----------------------------------	----------------	------------------	---------------------------------------

Customer Space Cabling Infrastructure

Overview	MDA Fiber	ToR Fiber	EoR Copper	FiberGuide Raceway
----------	-----------	-----------	------------	--------------------

Reference Designs and Technical Information

MDA Cabinet	MDA Cross-connect 19"	MDA Cross-connect FACT ODF	IDF FACT	IDF 19"
-------------	-----------------------	----------------------------	----------	---------



Review Pre-terminated 19" Fiber System Selection here.

All cable assemblies on this page fit to:

EPX

Evolve Mixed Media



ULL MPO/LC Array Cords

ULL MPO/LC Array Cords

MPO-12 and MPO-8 based breakout cables (MPO to LC)

LC-Duplex Uniboot for high density installations

LC-Duplex Uniboot connector with polarity change option

1 U	2 N	3 X	4 M	5 P	6 L	7 C	8 G	9 D	10 -	11 M	12 E	13 F	14-16 010
Construction type U Ultra-Low Loss	Cable Family N Array, LSZH CPR Dca 4 Array, LSZH CPRB2ca	Fiber type G TeraSPEED singlemode (A2) X LazrSPEED 550 multimode V LazrSPEED OM5 WB multimode	Connector 1 MP 12f MPO (female) MX 12f MPO (male) QP 8f MPO (female) QX 8f MPO (male)		Connector 2 LU LC Uniboot		Cordage size C 12-fiber PmP Array Cord T 8-fiber PmP	Fiber count for MX/MP D 12-fiber F 24-fiber H 48-fiber K 72-fiber L 96-fiber M 144-fiber		Color M Aqua N Lime green J Yellow LazrSPEED OM4 standard aqua LazrSPEED OM5 standard lime green TeraSPEED singlemode standard yellow	Breakout length J 22" Break Propel No Pull Grip K 22" Break Propel Pull Grip A 33" Break EPX/Mixed Media No Gland/No Pulling Grip B 33" Break EPX/Mixed Media With Gland/No Pulling Grip C 33" Break EPX/Mixed Media With Gland/Pulling Grip 2 33" to 60" Break EPX/Mixed Media To FACT/XFrame with Gland/No Pulling Grip 3 33" to 60" Break EPX/Mixed Media To FACT/XFrame with Gland/Pulling Grip W 60" Break FACT/XFrame to FACT/XFrame 7 22" to 60" Propel to FACT/XFrame with pulling grip	Unit of measure F Feet M Meter	Length minimal length based on breakout 12 in 3-999 ft 24 in 4-999 ft 48 in 6-999 ft 72 in 8-999 ft 96 in 10-999 ft 12 in 1-305 m 24-48 in 2-305 m 72 in 3-305 m 96 in 4-305 m

ULL LC/LC Array Trunks



ULL LC/LC Array Trunks

LC-Duplex Uniboot for high density installations

LC-Duplex Uniboot connector with polarity change option

1 U	2 N	3 X	4 M	5 P	6 L	7 C	8 G	9 D	10 -	11 M	12 E	13 F	14-16 010
Construction type U Ultra-Low Loss	Cable Family N Array, LSZH CPR Dca 4 Array, LSZH CPRB2ca	Fiber type G TeraSPEED singlemode (A2) X LazrSPEED 550 multimode V LazrSPEED OM5 WB multimode	Connector 1 LU LC Uniboot		Connector 2 LU LC Uniboot		Cordage size C 12-fiber PmP	Fiber count for MX/MP D 12-fiber F 24-fiber H 48-fiber K 72-fiber L 96-fiber M 144-fiber		Color M Aqua N Lime green J Yellow LazrSPEED OM4 standard aqua LazrSPEED OM5 standard lime green TeraSPEED singlemode standard yellow	Breakout length J 22" Break Propel No Pull Grip K 22" Break Propel Pull Grip A 33" Break EPX/Mixed Media No Gland/No Pulling Grip B 33" Break EPX/Mixed Media With Gland/No Pulling Grip C 33" Break EPX/Mixed Media With Gland/Pulling Grip 2 33" to 60" Break EPX/Mixed Media To FACT/XFrame with Gland/No Pulling Grip 3 33" to 60" Break EPX/Mixed Media To FACT/XFrame with Gland/Pulling Grip W 60" Break FACT/XFrame to FACT/XFrame 7 22" to 60" Propel to FACT/XFrame with pulling grip	Unit of measure F Feet M Meter	Length minimal length based on breakout 12 in 3-999 ft 24 in 4-999 ft 48 in 6-999 ft 72 in 8-999 ft 96 in 10-999 ft 12 in 1-305 m 24-48 in 2-305 m 72 in 3-305 m 96 in 4-305 m

Direct System Selection Index

Splice Closures	Building Entrance Solutions	FACT Optical Distribution Frame	Propel XFrame	19" Splice Solutions	Singlemode Fiber Cables	Pre-term 19" Fiber	Pre-term FACT ODF Fiber	Fiber Optic Patch Cords	FiberGuide	Copper Category 6A	Cable Management & Overhead Racks	FiberREACH
-----------------	-----------------------------	---------------------------------	---------------	----------------------	-------------------------	--------------------	-------------------------	-------------------------	------------	--------------------	-----------------------------------	------------

Architecture System Selection Index

Colocation Campus and Building Infrastructure

Fiber Entrance, Meet-Me Room	High Fiber Count DC Interconnect	Campus Cabling	Building Cabling	Campus Cabling for Wi-Fi and Security
------------------------------	----------------------------------	----------------	------------------	---------------------------------------

Customer Space Cabling Infrastructure

Overview	MDA Fiber	ToR Fiber	EoR Copper	FiberGuide Raceway
----------	-----------	-----------	------------	--------------------

Reference Designs and Technical Information

MDA Cabinet	MDA Cross-connect 19"	MDA Cross-connect FACT ODF	IDF FACT	IDF 19"
-------------	-----------------------	----------------------------	----------	---------



FACT-FACT Pre-Term

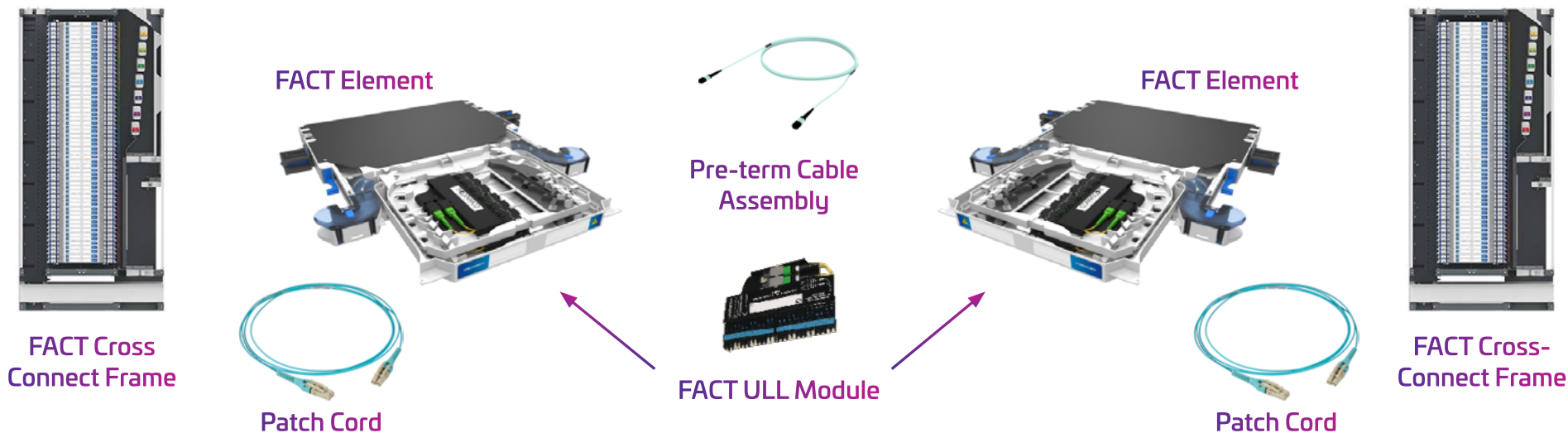

FACT-Panel Pre-Term

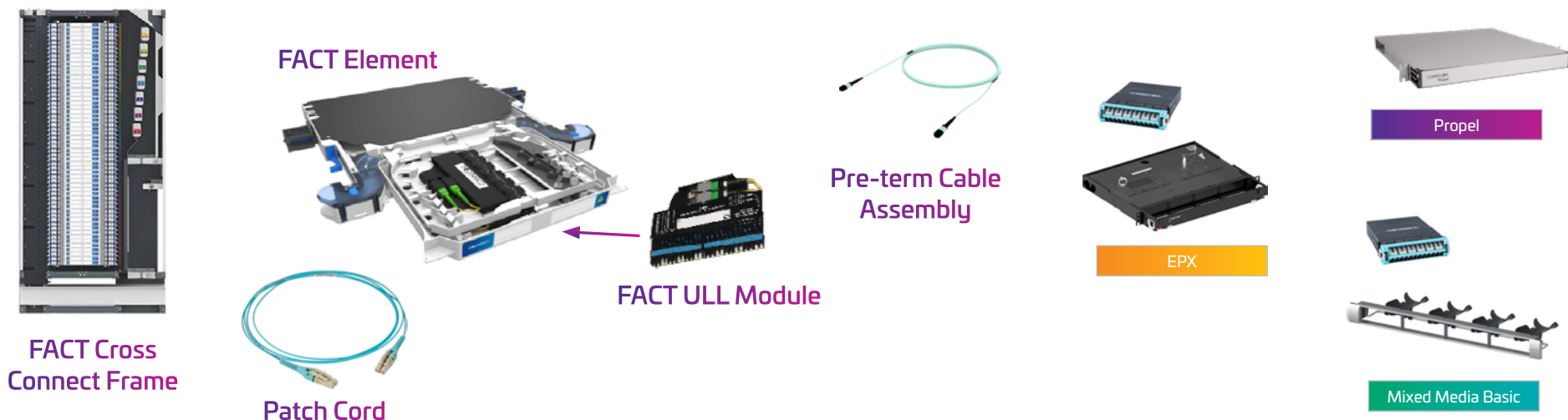

Direct System Selection Index

Splice Closures	Building Entrance Solutions	FACT Optical Distribution Frame	Propel XFrame	19" Splice Solutions	Singlemode Fiber Cables	Pre-term 19" Fiber	Pre-term FACT ODF Fiber	Fiber Optic Patch Cords	FiberGuide	Copper Category 6A	Cable Management & Overhead Racks	FiberREACH
-----------------	-----------------------------	---------------------------------	---------------	----------------------	-------------------------	--------------------	-------------------------	-------------------------	------------	--------------------	-----------------------------------	------------

Architecture System Selection Index

Colocation Campus and Building Infrastructure

Fiber Entrance, Meet-Me Room	High Fiber Count DC Interconnect	Campus Cabling	Building Cabling	Campus Cabling for Wi-Fi and Security
------------------------------	----------------------------------	----------------	------------------	---------------------------------------

Customer Space Cabling Infrastructure

Overview	MDA Fiber	ToR Fiber	EoR Copper	FiberGuide Raceway
----------	-----------	-----------	------------	--------------------

Reference Designs and Technical Information

MDA Cabinet	MDA Cross-connect 19"	MDA Cross-connect FACT ODF	IDF FACT	IDF 19"
-------------	-----------------------	----------------------------	----------	---------



Review Pre-terminated FACT ODF Fiber System Selection here.

FACT Frame		Description Code	Part Number		
FACT Cross Connect frame, patching on the right		FACT-FRCCRHP22	760243095		
FACT Cross Connect frame, patching on the Left		FACT-FRCLHP22	760243094		
FACT patch cord overlength management bay		FACT-FROLB22	760243097		
FACT Interconnect Frame – Right Hand Patch (2.2m)		FACT-FRICRHP22	760243096		
FACT Frame Accessories		Description Code	Part Number		
FACT Cross Connect door kit. Set of two doors with two door handles per door (one set per frame)		FACT-FRCCD22	760243098		
FACT Cross Connect side panel kit (pack of two side panels)		FACT-FRCCP22	760243099		
FACT Patch Cord Overlength Bay Door (2.2m)		FACT-FROLBD22	760243101		
FACT Interconnect Frame door kit		FACT-FRICD22	760243100		
FACT Fiber guide fixation kit		FACT-FRACCFGFS	760243110		
FACT-FRACCCAPL One cable attachment plate with one cable to flex conversion bracket included.		FACT-FRACCCAPL	760243108		
FACT-FRACCCTF One cable to flex conversion component set for cable attachment plate (one cable to flex component per cable)		FACT-FRACCCTF	760243111		
FACT-FRACCFOPL One fan out fixation plate for frame side duct & Eight fan out fixation component sets		FACT-FRACCFOPL	760243109		
Eight fan out fixation component sets (for fan out fixation plate) FACT		FACT-FRACCFOFK-8	760243112		
FACT Patch-Patch Elements and FACT NG4 Elements	Element Type	Fiber Count	Fiber Type	Description Code	Part Number
FACT Fiber Optic Patch Panel, blue, 6E high, 288-port simplex, multimode, OM4, holding 10 hinged trays loaded with LC/UPC adapters	Patch/Patch	288	OM4	FACT-6EPATL4	760240442
FACT Fiber Optic Patch Panel, blue, 6E high, 288-port simplex, singlemode, holding 10 hinged trays loaded with LC/UPC adapters	Patch/Patch	288	OS2	FACT-6EPATL1	760240441
FACT Fiber Optic Patch Panel, blue, 4E high, 192-port simplex, multimode, OM4, holding 8 hinged trays loaded with LC/UPC adapters	Patch/Patch	192	OM4	FACT-4EPATL4	760239995
FACT Fiber Optic Patch Panel, blue, 4E high, 192-port simplex, singlemode, holding 8 hinged trays loaded with LC/UPC adapters	Patch/Patch	192	OS2	FACT-4EPATL1	760239993
FACT Fiber Optic Patch Panel, blue, 3E high, 144-port simplex, multimode, OM4, holding 6 hinged trays loaded with LC/UPC adapters	Patch/Patch	144	OM4	FACT-3EPATL4	760239990
FACT Fiber Optic Patch Panel, blue, 3E high, 144-port simplex, singlemode, holding 6 hinged trays loaded with LC/UPC adapters	Patch/Patch	144	OS2	FACT-3EPATL1	760239988
FACT Fiber Optic Patch Panel, blue, 2E high, 96-port simplex, multimode, OM4, holding 4 hinged trays loaded with LC/UPC adapters	Patch/Patch	96	OM4	FACT-2EPATL4	760239984
FACT Fiber Optic Patch Panel, blue, 2E high, 96-port simplex, singlemode, holding 4 hinged trays loaded with LC/UPC adapters	Patch/Patch	96	OS2	FACT-2EPATL1	760239982
FACT Fiber Optic Patch Panel, blue, 1E high, 48-port simplex, multimode, OM4, holding 2 hinged trays loaded with LC/UPC adapters	Patch/Patch	48	OM4	FACT-1EPATL4	760240416
FACT Fiber Optic Patch Panel, blue, 1E high, 48-port simplex, singlemode, holding 2 hinged trays loaded with LC/UPC adapters	Patch/Patch	48	OS2	FACT-1EPATL1	760240414
FACT NG4 Fiber Panel, with 12 unloaded trays, blue, 6E high, for holding 12 NG4 MPO modules	NG4 Module	288	Universal	FACT-6ENG4	760242087
FACT NG4 Fiber Panel, with 8 unloaded trays, blue, 4E high, for holding 8 NG4 MPO modules	NG4 Module	192	Universal	FACT-4ENG4	760239978
FACT NG4 Fiber Panel, with 6 unloaded trays, blue, 3E high, for holding 6 NG4 MPO modules	NG4 Module	144	Universal	FACT-3ENG4	760239977
FACT NG4 Fiber Panel, with 4 unloaded trays, blue, 2E high, for holding 4 NG4 MPO modules	NG4 Module	96	Universal	FACT-2ENG4	760239976
FACT NG4 Fiber Panel, with 2 unloaded trays, blue, 1E high, for holding 2 NG4 MPO modules	NG4 Module	48	Universal	FACT-1ENG4	760239975
FACT NG4 Module	Cable Entrance		Fiber Type	Description Code	Part Number
FACT left sided ULL module, MPO24f to 12x LC-D, OM4	Left		OM4	FACT-MMDLC2-B	760244652
FACT right sided ULL module, MPO24f to 12x LC-D, OM4	Right		OM4	FACT-MMDRC2-B	760244653
FACT left sided ULL module, MPO24f to 12x LC-D, OM5	Left		OM5	FACT-MMDL52-B	760244851
FACT right sided ULL module, MPO24f to 12x LC-D, OM5	Right		OM5	FACT-MMDR52-B	760244852
FACT left sided ULL module, 2 x MPO12f to 12x LC-D, OS2	Left		OS2	FACT-MMDLKE-B	760244558
FACT right sided ULL module, 2 x MPO12f to 12x LC-D, OS2	Right		OS2	FACT-MMDRKE-B	760244559

Direct System Selection Index

Splice Closures	Building Entrance Solutions	FACT Optical Distribution Frame	Propel XFrame	19" Splice Solutions	Singlemode Fiber Cables	Pre-term 19" Fiber	Pre-term FACT ODF Fiber	Fiber Optic Patch Cords	FiberGuide	Copper Category 6A	Cable Management & Overhead Racks	FiberREACH
-----------------	-----------------------------	---------------------------------	---------------	----------------------	-------------------------	--------------------	-------------------------	-------------------------	------------	--------------------	-----------------------------------	------------

Architecture System Selection Index

Colocation Campus and Building Infrastructure

Fiber Entrance, Meet-Me Room	High Fiber Count DC Interconnect	Campus Cabling	Building Cabling	Campus Cabling for Wi-Fi and Security
------------------------------	----------------------------------	----------------	------------------	---------------------------------------

Customer Space Cabling Infrastructure

Overview	MDA Fiber	ToR Fiber	EoR Copper	FiberGuide Raceway
----------	-----------	-----------	------------	--------------------

Reference Designs and Technical Information

MDA Cabinet	MDA Cross-connect 19"	MDA Cross-connect FACT ODF	IDF FACT	IDF 19"
-------------	-----------------------	----------------------------	----------	---------



Fiber Optic Patch Cords



ULL LC-Duplex Patch Cords

Patch Cords	Patch Cord Type	Application	Fiber Type	Description Code	Part Number
Ultra Low Loss (ULL) LazrSPEED 550 OM4 LC Uniboot to LC Uniboot, Fiber Patch Cord, 1.5 mm Duplex, LSZH/Riser	LC-D to LC-D, 1.5 mm diameter, LSZH/Riser	Distribution/XC	OM4	UFXLULUK2	UFXLULUK2
Ultra Low Loss (ULL) LazrSPEED 550 WideBand OM5 LC Uniboot to LC Uniboot, Fiber Patch Cord, 1.5 mm Duplex, LSZH/Riser	LC-D to LC-D, 1.5 mm diameter, LSZH/Riser	Distribution/XC	OM5	UFVLULUK2	UFVLULUK2
Ultra Low Loss (ULL) TeraSPEED LC Uniboot to LC Uniboot, Fiber Patch Cord, 1.5 mm Duplex, LSZH/Riser	LC-D to LC-D, 1.5 mm diameter, LSZH/Riser	Distribution/XC	OS2	UFGLLULUK2	UFGLLULUK2
Ultra Low Loss (ULL) LazrSPEED 550 OM4 LC Uniboot to LC Uniboot, Fiber Patch Cord, 2.0 mm Duplex, LSZH/Riser	LC-D to LC-D, 2 mm diameter, LSZH/Riser	Equipment Area	OM4	UFXLULU62	UFXLULU62
Ultra Low Loss (ULL) LazrSPEED 550 WideBand OM5 LC Uniboot to LC Uniboot, Fiber Patch Cord, 2.0 mm Duplex, LSZH/Riser	LC-D to LC-D, 2 mm diameter, LSZH/Riser	Equipment Area	OM5	UFVLULU62	UFVLULU62
Ultra Low Loss (ULL) TeraSPEED LC Uniboot to LC Uniboot, Fiber Patch Cord, 2.0 mm Duplex, LSZH/Riser	LC-D to LC-D, 2 mm diameter, LSZH/Riser	Equipment Area	OS2	UFGLLULU62	UFGLLULU62



LSH/LSH

	Length	Description Code
	1 m	OCJ-EC-01MASIA-EC
	2 m	OCJ-EC-02MASIA-EC
	3 m	OCJ-EC-03MASIA-EC
	5 m	OCJ-EC-05MASIA-EC
	10 m	OCJ-EC-10MASIA-EC
	15 m	OCJ-EC-15MASIA-EC
	20 m	OCJ-EC-20MASIA-EC

LSH/LC APC

	Length	Description Code
	2 m	OCJ-EC-02MASIA-LG
	5 m	OCJ-EC-05MASIA-LG
	10 m	OCJ-EC-10MASIA-LG
	15 m	OCJ-EC-15MASIA-LG

LSH/LC UPC

	Length	Description Code
	2 m	OCJ-EC-02MASIA-LF
	5 m	OCJ-EC-05MASIA-LF
	10 m	OCJ-EC-10MASIA-LF
	15 m	OCJ-EC-15MASIA-LF

Direct System Selection Index

Splice Closures	Building Entrance Solutions	FACT Optical Distribution Frame	Propel XFrame	19" Splice Solutions	Singlemode Fiber Cables	Pre-term 19" Fiber	Pre-term FACT ODF Fiber	Fiber Optic Patch Cords	FiberGuide	Copper Category 6A	Cable Management & Overhead Racks	FiberREACH
-----------------	-----------------------------	---------------------------------	---------------	----------------------	-------------------------	--------------------	-------------------------	-------------------------	------------	--------------------	-----------------------------------	------------

Architecture System Selection Index

Colocation Campus and Building Infrastructure

Fiber Entrance, Meet-Me Room	High Fiber Count DC Interconnect	Campus Cabling	Building Cabling	Campus Cabling for Wi-Fi and Security
------------------------------	----------------------------------	----------------	------------------	---------------------------------------

Customer Space Cabling Infrastructure

Overview	MDA Fiber	ToR Fiber	EoR Copper	FiberGuide Raceway
----------	-----------	-----------	------------	--------------------

Reference Designs and Technical Information

MDA Cabinet	MDA Cross-connect 19"	MDA Cross-connect FACT ODF	IDF FACT	IDF 19"
-------------	-----------------------	----------------------------	----------	---------



Propel MPO-8 Singlemode & Multimode Patch Cords

1 U	2 R	3 X	4 Q	5 P	6 Q	7 P	8 F	9 8	10 -	11 M	12 A	13 F	14-16 003
Construction type U Ultra-low loss	Cable family R Dual Rated (OFNR/LSZH)	Fiber type G Singlemode (A2) X OM4 multimode V OM5 WB multimode	Connector 1 QP 8f MPO UPC (Non-Pinned) QV 8f MPO APC (Non-Pinned)		Connector 2 QP 8f MPO UPC (Non-Pinned) QV 8f MPO APC (Non-Pinned)		Cordage size F 8f MP Patch/Array Cable, 2.00 mm	Fiber count 8 8-fiber	Color M OM4 Aqua N OM5 Lime green J Yellow		Breakout length A No Gland	UOM F Feet M Meter	Length 010-999 ft 003-305 m

Propel MPO-12 Singlemode & Multimode Patch Cords

1 U	2 R	3 X	4 M	5 P	6 M	7 P	8 U	9 D	10 -	11 M	12 A	13 F	14-16 003
Construction type U Ultra-low loss	Cable family R Dual Rated (OFNR/LSZH)	Fiber type G Singlemode (A2) X OM4 multimode V OM5 WB multimode	Connector 1 MP 12f MPO (Non-Pinned)		Connector 2 MP 12f MPO (Non-Pinned)		Cordage size U 12f PMP Array Cord, 2.00 mm	Fiber count D 12-fiber	Color M OM4 Aqua N OM5 Lime green J Yellow		Breakout length A No Gland	UOM F Feet M Meter	Length 010-999 ft 003-305 m

Propel MPO-16 (APC) Singlemode & Multimode Patch Cords

1 U	2 R	3 X	4 R	5 P	6 R	7 P	8 7	9 R	10 -	11 M	12 A	13 F	14-16 003
Construction type U Ultra-low loss	Cable family R Dual Rated (OFNR/LSZH)	Fiber type G Singlemode (A2) X OM4 multimode V OM5 WB multimode	Connector 1 RP 16f MPO, Singlemode (Non-Pinned) RV 16f MPO, Multimode (Non-Pinned)		Connector 2 RP 16f MPO, Singlemode (Non-Pinned) RV 16f MPO, Multimode (Non-Pinned)		Cordage size 7 16f MP Patch/Array Cable, 3.00 mm	Fiber count R 16-fiber	Color M OM4 Aqua N OM5 Lime green J Yellow		Breakout length A No Gland	UOM F Feet M Meter	Length 010-999 ft 003-305 m

Direct System Selection Index

Splice Closures	Building Entrance Solutions	FACT Optical Distribution Frame	Propel XFrame	19" Splice Solutions	Singlemode Fiber Cables	Pre-term 19" Fiber	Pre-term FACT ODF Fiber	Fiber Optic Patch Cords	FiberGuide	Copper Category 6A	Cable Management & Overhead Racks	FiberREACH
-----------------	-----------------------------	---------------------------------	---------------	----------------------	-------------------------	--------------------	-------------------------	-------------------------	------------	--------------------	-----------------------------------	------------

Architecture System Selection Index

Colocation Campus and Building Infrastructure

Fiber Entrance, Meet-Me Room	High Fiber Count DC Interconnect	Campus Cabling	Building Cabling	Campus Cabling for Wi-Fi and Security
------------------------------	----------------------------------	----------------	------------------	---------------------------------------

Customer Space Cabling Infrastructure

Overview	MDA Fiber	ToR Fiber	EoR Copper	FiberGuide Raceway
----------	-----------	-----------	------------	--------------------

Reference Designs and Technical Information

MDA Cabinet	MDA Cross-connect 19"	MDA Cross-connect FACT ODF	IDF FACT	IDF 19"
-------------	-----------------------	----------------------------	----------	---------



Propel MPO-8 Singlemode & Multimode Breakout Assembly

1 U	2 R	3 G	4 Q	5 P	6 L	7 U	8 F	9 8	10 -	11 M	12 D	13 F	14-16 003
Construction type U Ultra-low loss	Cable family R Dual Rated (OFNR/LSZH)	Fiber type G Singlemode (A2) X OM4 multimode V OM5 WB multimode	Connector 1 QP 8f MPO UPC (Non-Pinned) QV 8f MPO APC (Non-Pinned)		Connector 2 LU LC Uniboot		Cordage size F 8f MP Patch/Array Cable, 2.00 mm	Fiber count 8 8-fiber	Color M OM4 Aqua N OM5 Lime green J OS2 Yellow		Breakout length D 12" E 24" H 48" L 72"	UOM F Feet M Meter	Length 12 in 3-999 ft 24 in 4-999 ft 48 in 6-999 ft 72 in 8-999 ft 12 in 1-305 m 24-48 in 2-305 m 72 in 3-305 m

Propel MPO-12 Singlemode & Multimode Breakout Assembly

1 U	2 R	3 G	4 M	5 P	6 L	7 U	8 U	9 D	10 -	11 M	12 D	13 F	14-16 003
Construction type U Ultra-low loss	Cable family R Dual Rated (OFNR/LSZH)	Fiber type G Singlemode (A2) X OM4 multimode V OM5 WB multimode	Connector 1 MP 12f MPO (Non-pinned) MX 12f MPO (Pinned)		Connector 2 LU LC Uniboot		Cordage size U 12f PmP Array Cord, 2.00 mm	Fiber count D 12-fiber	Color M OM4 Aqua N OM5 Lime green J OS2 Yellow		Breakout length D 12" E 24" H 48" L 72"	UOM F Feet M Meter	Length 12 in 3-999 ft 24 in 4-999 ft 48 in 6-999 ft 72 in 8-999 ft 12 in 1-305 m 24-48 in 2-305 m 72 in 3-305 m

Propel MPO-16 (APC) Singlemode & Multimode Breakout Assembly

1 U	2 R	3 X	4 R	5 P	6 L	7 U	8 7	9 R	10 -	11 M	12 A	13 F	14-16 003
Construction type U Ultra-low loss	Cable family R Dual Rated (OFNR/LSZH)	Fiber type G Singlemode (A2) X OM4 multimode V OM5 WB multimode	Connector 1 RP 16f MPO, Singlemode (Non-Pinned) RV 16f MPO, Multimode (Non-Pinned)		Connector 2 LU LC Uniboot		Cordage size 7 16f MP Patch/Array Cable, 3.00 mm	Fiber count R 16-fiber	Color M OM4 Aqua N OM5 Lime green J OS2 Yellow		Breakout length D 12" E 24" H 48" L 72"	UOM F Feet M Meter	Length 12 in 3-999 ft 24 in 4-999 ft 48 in 6-999 ft 72 in 8-999 ft 12 in 1-305 m 24-48 in 2-305 m 72 in 3-305 m

Direct System Selection Index

Splice Closures	Building Entrance Solutions	FACT Optical Distribution Frame	Propel XFrame	19" Splice Solutions	Singlemode Fiber Cables	Pre-term 19" Fiber	Pre-term FACT ODF Fiber	Fiber Optic Patch Cords	FiberGuide	Copper Category 6A	Cable Management & Overhead Racks	FiberREACH
-----------------	-----------------------------	---------------------------------	---------------	----------------------	-------------------------	--------------------	-------------------------	-------------------------	------------	--------------------	-----------------------------------	------------

Architecture System Selection Index

Colocation Campus and Building Infrastructure

Fiber Entrance, Meet-Me Room	High Fiber Count DC Interconnect	Campus Cabling	Building Cabling	Campus Cabling for Wi-Fi and Security
------------------------------	----------------------------------	----------------	------------------	---------------------------------------

Customer Space Cabling Infrastructure

Overview	MDA Fiber	ToR Fiber	EoR Copper	FiberGuide Raceway
----------	-----------	-----------	------------	--------------------

Reference Designs and Technical Information

MDA Cabinet	MDA Cross-connect 19"	MDA Cross-connect FACT ODF	IDF FACT	IDF 19"
-------------	-----------------------	----------------------------	----------	---------





MPO16 1x2 Conversion Cables

1 U	2 O	3 X	4 R	5 V	6 O	7 P	8 7	9 R	10 -	11 M	12 D	13 F	14-16 003
Construction type U Ultra-Low Loss	Cable family R Dual Rated (OFNR/LSZH)	Fiber type X OM4 multimode V OM5 WB multimode G Singlemode (A2)	Connector 1 RV 16f MPO MM APC (Non-Pinned) RP 16f MPO SM APC (Non-Pinned)		Connector 2 QP 8f MPO MM UPC (Non-Pinned) QV 8f MPO MM APC (Non-Pinned) QP 8f MPO SM APC (Non-Pinned)		Cordage size 7 16f PmP Array Cord, 3.00 mm	Fiber count R 16-fiber	Color M OM4 Aqua N OM5 Lime green J Yellow OS2		Breakout length D 12" E 24" H 48" L 72"	UOM F Feet M Meter	Length 12 in 3-999 ft 24 in 4-999 ft 48 in 6-999 ft 72 in 8-999 ft 12 in 1-305 m 24-48 in 2-305 m 72 in 3-305 m

Direct System Selection Index

Splice Closures	Building Entrance Solutions	FACT Optical Distribution Frame	Propel XFrame	19" Splice Solutions	Singlemode Fiber Cables	Pre-term 19" Fiber	Pre-term FACT ODF Fiber	Fiber Optic Patch Cords	FiberGuide	Copper Category 6A	Cable Management & Overhead Racks	FiberREACH
-----------------	-----------------------------	---------------------------------	---------------	----------------------	-------------------------	--------------------	-------------------------	-------------------------	------------	--------------------	-----------------------------------	------------

Architecture System Selection Index

Colocation Campus and Building Infrastructure

Fiber Entrance, Meet-Me Room	High Fiber Count DC Interconnect	Campus Cabling	Building Cabling	Campus Cabling for Wi-Fi and Security
------------------------------	----------------------------------	----------------	------------------	---------------------------------------

Customer Space Cabling Infrastructure

Overview	MDA Fiber	ToR Fiber	EoR Copper	FiberGuide Raceway
----------	-----------	-----------	------------	--------------------

Reference Designs and Technical Information

MDA Cabinet	MDA Cross-connect 19"	MDA Cross-connect FACT ODF	IDF FACT	IDF 19"
-------------	-----------------------	----------------------------	----------	---------



FiberGuide[®] Raceway Systems



FiberGuide® Raceway Systems

CommScope's FiberGuide solution is a raceway system designed to protect and route fiber-optic patch cords between fiber splice enclosures, fiber distribution frames and fiber-optic terminal devices. FiberGuide ensures that a two-inch minimum bend radius is maintained throughout the system. Tool-less Snap-Fit® junctions, cover options and Plenum Express Exit® drops all significantly reduce installation time.

The FiberGuide system is a complete set of products designed and manufactured to ensure total off-frame protection and ease of use. Basic components include horizontal and vertical straight sections, horizontal and vertical elbows, downspouts, junctions, as well as numerous support hardware and flex-tube kits.

Speed of installation

FiberGuide systems feature a variety of products that allow for quick and easy installation. Express Exit drops, as well as tool-less products including Snap-Fit junctions, snap-on covers and new hinged cover options, all save valuable time for installers.

Speed of deployment

The Express Exit system enables new drops to be added (or exiting ones to be removed) quickly and easily. A drop can be added into a fully loaded raceway in seconds—without cutting.

Raceway flexibility and durability

FiberGuide is built for strength and durability, featuring 38 support structures, more than 75 fittings, multiple drop options and several other components to suit any application you require.

Fiber protection

Our broadband expertise translates into maximum protection for your network. A two-inch minimum bend radius is maintained throughout the system regardless of the raceway size.



Direct System Selection Index

Splice Closures	Building Entrance Solutions	FACT Optical Distribution Frame	Propel XFrame	19" Splice Solutions	Singlemode Fiber Cables	Pre-term 19" Fiber	Pre-term FACT ODF Fiber	Fiber Optic Patch Cords	FiberGuide	Copper Category 6A	Cable Management & Overhead Racks	FiberREACH
-----------------	-----------------------------	---------------------------------	---------------	----------------------	-------------------------	--------------------	-------------------------	-------------------------	------------	--------------------	-----------------------------------	------------

Architecture System Selection Index

Colocation Campus and Building Infrastructure

Fiber Entrance, Meet-Me Room	High Fiber Count DC Interconnect	Campus Cabling	Building Cabling	Campus Cabling for Wi-Fi and Security
------------------------------	----------------------------------	----------------	------------------	---------------------------------------

Customer Space Cabling Infrastructure

Overview	MDA Fiber	ToR Fiber	EoR Copper	FiberGuide Raceway
----------	-----------	-----------	------------	--------------------

Reference Designs and Technical Information

MDA Cabinet	MDA Cross-connect 19"	MDA Cross-connect FACT ODF	IDF FACT	IDF 19"
-------------	-----------------------	----------------------------	----------	---------







Review additional FiberGuide products here.



4-in. x 6-in. FiberGuide System

Description	Part Number	
4x6 Horizontal Straight Section, 6-ft. long, yellow	FGS-MSHS-B	
4x6 Horizontal Stack Storage Section, yellow	FGS-MSHS-STOR-B	
4x6 Horizontal T, yellow	FGS-MHRT-B	
4x6 Horizontal Cross, yellow	FGS-MHXP-B	
4x6 Horizontal Elbow 90°, yellow	FGS-MH9E-B	
4x6 Down Spout, yellow	FGS-MDSP-B	
4x6 Trumpet Flare, yellow	FGS-MTRM-B	
4x6 Down Elbow 45°, yellow	FGS-MD4E-B	
4x6 Up Elbow 45°, yellow	FGS-MU4E-B	
4x6 Junction	FGS-MFAW-B	
4x6 End Cap, black	FGS-HMEC-B	

4-in. x 6-in. Supports

Description	Part Number	
L Bay Support Bracket	FGS-HLBK	
Center Support Bracket Kit (xx = size: 1/2-in., 5/8-in., 12 mm, 14 mm, 16 mm)	FGS-HTUB	
Top Support C-Bracket Kit (xx = size: 1/2-in., 5/8-in., 12 mm, 14 mm, 16 mm)	FGS-HNTS	
Unistrut Kit; 10 Quick Knob T-Bolt	FGS-ACC532	

Express Exits

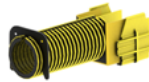
Description	Part Number	
4-in. Express Exit with 4x4 exit opening, yellow	FGS-MEXP-E-A/B/F	
2-in. Low Profile Express Exit with 2x2 exit opening, yellow	FGS-MEXP-LP-A/B/F	
2x2 Trumpet Flare for 2-in. Express Exits, yellow	FGS-MTRM-C	
Single 2-in. Flex Tube Attachment 2-in. flex tube and 2x2 junction to attach to Express Exit		
5-ft. length	FGS-MEXI-C-5F	
10-ft. length	FGS-MEXI-C-10F	
15-ft. length	FGS-MEXI-C-15F	

Direct System Selection Index

Splice Closures	Building Entrance Solutions	FACT Optical Distribution Frame	Propel XFrame	19" Splice Solutions	Singlemode Fiber Cables	Pre-term 19" Fiber	Pre-term FACT ODF Fiber	Fiber Optic Patch Cords	FiberGuide	Copper Category 6A	Cable Management & Overhead Racks	FiberREACH
-----------------	-----------------------------	---------------------------------	---------------	----------------------	-------------------------	--------------------	-------------------------	-------------------------	------------	--------------------	-----------------------------------	------------

Architecture System Selection Index

Colocation Campus and Building Infrastructure

Fiber Entrance, Meet-Me Room	High Fiber Count DC Interconnect	Campus Cabling	Building Cabling	Campus Cabling for Wi-Fi and Security
------------------------------	----------------------------------	----------------	------------------	---------------------------------------

Customer Space Cabling Infrastructure

Overview	MDA Fiber	ToR Fiber	EoR Copper	FiberGuide Raceway
----------	-----------	-----------	------------	--------------------

Reference Designs and Technical Information

MDA Cabinet	MDA Cross-connect 19"	MDA Cross-connect FACT ODF	IDF FACT	IDF 19"
-------------	-----------------------	----------------------------	----------	---------



Review additional FiberGuide products here.

4-in. x 12-in. FiberGuide System

Description	Part Number	
4x12 Horizontal Straight Section, 6-ft. long, yellow	FGS-MSHS-F	
4x12 Horizontal Slack Storage Section, yellow	FGS-MSHS-STOR-F	
4x12 Horizontal T, yellow	FGS-MHRT-F	
4x12 Horizontal Cross, yellow	FGS-MHXP-F	
4x12 Horizontal Elbow 90°, yellow	FGS-MH9E-F	
4x12 Down Spout, yellow	FGS-MDSP-F	
4x12 Trumpet Flare, yellow	FGS-MTRM-F	
4x12 Horizontal Cross with two 6-in. exit, yellow	FGS-MHXP-B/F	
4x12 Down Elbow 45°, yellow	FGS-MD4E-F	
4x12 Up Elbow 45°, yellow	FGS-MU4E-F	
4x12 Junction	FGS-MFAW-F	
4x12 End Cap	FGS-HMEC-F	
Trapeze Bracket Kit (xx = size: 1/2-in., 5/8-in., 12 mm, 16 mm)	FGS-HNTP-F-XX	

4-in. x 24-in. FiberGuide System

Description	Part Number	
4x24 Horizontal Straight Section, 6-in. long, yellow	FGS-MSHS-H	
4x24 Horizontal T, with single 12-in. exit, yellow	FGS-MHRT-H/F	
4x24 Horizontal T with three 24-in. exits, yellow	FGS-MHRT-H	
4x24 Horizontal Cross, yellow	FGS-MHXP-H	
4x24 Horizontal Cross with dual 12-in. exits	FGS-MHXP-F/H	
4x24 Horizontal Elbow 45°, yellow	FGS-MH4E-H	
4x24 Down Elbow 45°, yellow	FGS-MD4E-H	
4x24 Up Elbow 45°, yellow	FGS-MU4E-H	
4x24 Junction	FGS-MFAW-H	
4x24 End Cap	FGS-HMEC-H	
Threated Rod Trapeze Bracket, 16 mm	FGS-HNTP-H-16 MM	

Direct System Selection Index

Splice Closures	Building Entrance Solutions	FACT Optical Distribution Frame	Propel XFrame	19" Splice Solutions	Singlemode Fiber Cables	Pre-term 19" Fiber	Pre-term FACT ODF Fiber	Fiber Optic Patch Cords	FiberGuide	Copper Category 6A	Cable Management & Overhead Racks	FiberREACH
-----------------	-----------------------------	---------------------------------	---------------	----------------------	-------------------------	--------------------	-------------------------	-------------------------	------------	--------------------	-----------------------------------	------------

Architecture System Selection Index

Colocation Campus and Building Infrastructure

Fiber Entrance, Meet-Me Room	High Fiber Count DC Interconnect	Campus Cabling	Building Cabling	Campus Cabling for Wi-Fi and Security
------------------------------	----------------------------------	----------------	------------------	---------------------------------------

Customer Space Cabling Infrastructure

Overview	MDA Fiber	ToR Fiber	EoR Copper	FiberGuide Raceway
----------	-----------	-----------	------------	--------------------











Reference Designs and Technical Information

MDA Cabinet	MDA Cross-connect 19"	MDA Cross-connect FACT ODF	IDF FACT	IDF 19"
-------------	-----------------------	----------------------------	----------	---------



Category 6A Systems

Pre-terminated
Field Installable
Unshielded
Shielded

Evolve U/UTP Panel, Field Installable		Copper Tech	Description Code	Part Number	
	SYSTIMAX GigaSPEED X10D Evolve 1U U/UTP Panel Kit	U/UTP	360-E-MOD-1U-24	760187187	
Evolve Mixed Media Panels		Copper Tech	Description Code	Part Number	
	SYSTIMAX GigaSPEED X10D and GigaSPEED XL Evolve 1U U/UTP Panel Kit	U/UTP	360-E-KIT-1U	760155739	
	SYSTIMAX GigaSPEED X10D Evolve 1U F/UTP Panel Kit	F/UTP	360-IPR-MFTP-E-HD6B-1U-24	760150144	
Evolve Mixed Media Panels Accessories			Description Code	Part Number	
SYSTIMAX 360 1100 Evolve G2 BEZEL (Cool Gray)			360-1100-E-FB-4PK	760175877	
SYSTIMAX 360 1100 Evolve Fiber Cable Management			361 1100-E-FCM	760175919	
SYSTIMAX 360 1100 Evolve G2 BEZEL (Blank)			360-1100-E-BB	760165191	
InstaPATCH® Copper Trunks Pre-terminated		Copper Tech	Jacket Material	Description Code	Part Number
	InstaPATCH Cu U/UTP LSZH Pre-terminated Copper Cable, 360 1100 Evolve module to 360 1100 Evolve module, 6 links	U/UTP	LSZH	CCRRB-11SA08	CCRRB-11SA08
	InstaPATCH Cu F/UTP LSZH Copper Cable, single row standard density outlet to single row standard density outlet, 6 links	F/UTP	LSZH	CFAAB-11SA08	CFAAB-11SA08
Field Installable Category 6A Copper Cable		Copper Tech	Jacket Material	Description Code	Part Number
	GigaSPEED X10D 3091B-C ETL Verified Category 6A U/UTP Cable, blue jacket, 4 pair count, 1000 ft (305 m) length, WE TOTE® box	U/UTP	LSZH/B2ca	3091B-C BL 4/23 W1000	760240844
	GigaSPEED X10D 3291B Category 6A F/UTP Cable, low smoke zero halogen, white jacket, 4 pair count, 1000 ft (305 m) length, reel	F/UTP	LSZH/Dca	3291B WHT C6A 4/23 F/UTP R1000	760081323
Field Installable Category 6A Information Outlets		Copper Tech	Jacket Material	Description Code	Part Number
	GigaSPEED X10D MGS600 Series Information Outlet, black	UTP	N/A	MGS600-003	760092361
	GigaSPEED X10D HGS620 Shielded High Density Information Outlet	STP	N/A	HGS620	760152801
Copper Patch Cords		Copper Tech	Jacket Material	Description Code	Part Number
	MiNo6A Series Category 6A U/UTP Reduced Diameter LS-CM Dual Rated Cord	S/FTP	LSZH/Riser	G10SP-L-WH	C0199K2-08
	GigaSPEED X10D G10SP on S/FTP Low Smoke Zero Halogen Cordage, S/FTP Modular Patch Cord, White Jacket	S/FTP	LSZH/Riser	G10SP-L-WH	CA111K2-08



Direct System Selection Index

Splice Closures	Building Entrance Solutions	FACT Optical Distribution Frame	Propel XFrame	19" Splice Solutions	Singlemode Fiber Cables	Pre-term 19" Fiber	Pre-term FACT ODF Fiber	Fiber Optic Patch Cords	FiberGuide	Copper Category 6A	Cable Management & Overhead Racks	FiberREACH
-----------------	-----------------------------	---------------------------------	---------------	----------------------	-------------------------	--------------------	-------------------------	-------------------------	------------	--------------------	-----------------------------------	------------

Architecture System Selection Index

Colocation Campus and Building Infrastructure

Fiber Entrance, Meet-Me Room	High Fiber Count DC Interconnect	Campus Cabling	Building Cabling	Campus Cabling for Wi-Fi and Security
------------------------------	----------------------------------	----------------	------------------	---------------------------------------

Customer Space Cabling Infrastructure

Overview	MDA Fiber	ToR Fiber	EoR Copper	FiberGuide Raceway
----------	-----------	-----------	------------	--------------------

Reference Designs and Technical Information

MDA Cabinet	MDA Cross-connect 19"	MDA Cross-connect FACT ODF	IDF FACT	IDF 19"
-------------	-----------------------	----------------------------	----------	---------



Cable Management & Overhead Racks

Horizontal Slack Storage

- 5U
- For patch cord overlength storage in cabinets
- Part number [1671711-1](#)



Horizontal Trough

- 2U
- Single-sided
- Part number [760259385](#)



ZeroU Cable Manager

- For guiding patch cords to the side of the panel
- Bend radius control
- 2 pcs. to be ordered per RU
- 1U: [2269081-1](#)
- 2U: [2269081-2](#)
- 4U: [2269081-4](#)
- 6U: [2269081-6](#)
- 15U: [1-2269081-5](#)



Overhead Racks

- For installation above cabinets at raceways
- Includes Mini Vertical Cable Management
- 4U variant
Part number [760158592](#)
- 6U variant
Part number [760169599](#)
- Wirebasket Installation Kit
Part number [760165282](#)



Blank Panel

- 1U
Part number [760162065](#)



Patch Cord Management Panel

- 1U
Part number [760038240](#)



Direct System Selection Index

Splice Closures	Building Entrance Solutions	FACT Optical Distribution Frame	Propel XFrame	19" Splice Solutions	Singlemode Fiber Cables	Pre-term 19" Fiber	Pre-term FACT ODF Fiber	Fiber Optic Patch Cords	FiberGuide	Copper Category 6A	Cable Management & Overhead Racks	FiberREACH
-----------------	-----------------------------	---------------------------------	---------------	----------------------	-------------------------	--------------------	-------------------------	-------------------------	------------	--------------------	-----------------------------------	------------

Architecture System Selection Index

Colocation Campus and Building Infrastructure

Fiber Entrance, Meet-Me Room	High Fiber Count DC Interconnect	Campus Cabling	Building Cabling	Campus Cabling for Wi-Fi and Security
------------------------------	----------------------------------	----------------	------------------	---------------------------------------

Customer Space Cabling Infrastructure

Overview	MDA Fiber	ToR Fiber	EoR Copper	FiberGuide Raceway
----------	-----------	-----------	------------	--------------------

Reference Designs and Technical Information

MDA Cabinet	MDA Cross-connect 19"	MDA Cross-connect FACT ODF	IDF FACT	IDF 19"
-------------	-----------------------	----------------------------	----------	---------



FiberREACH Platform



High-capacity data. High-wattage power.

CommScope FiberREACH solutions enable your expanding network

Connected devices are now everywhere in buildings and across campuses—devices like small cells, Wi-Fi® access points, IP cameras, building access and inventory controls, and many more.

All these new applications improve end-user experience, operational efficiency, and property-wide safety and security. But they also present a new and growing challenge: how to get high-bandwidth data and power connectivity to every device in every location, indoors and out, with the low latency needed to maximize edge network architecture and deliver high performance.

CommScope FiberREACH solutions make it easy to overcome these challenges in a simple, straightforward way, with options designed for weatherized outdoor deployments or plenum rated indoor installations.

One cable run, infinite possibilities

CommScope FiberREACH solutions combine high-performance, low-latency fiber-optic data connectivity with a low-voltage copper direct current (DC) power connection. This enables the connection of powered remote devices without the need for new conduit, bulky extra cable runs, or certified electricians. With FiberREACH solutions, your network gains access to a vast and growing ecosystem of applications, including:

- Power over Ethernet (PoE) distance extension
- Optical LAN
- Emergency phones
- HD security cameras
- Digital signage
- Wi-Fi access points
- Small cells
- Or virtually any low-voltage DC-powered device

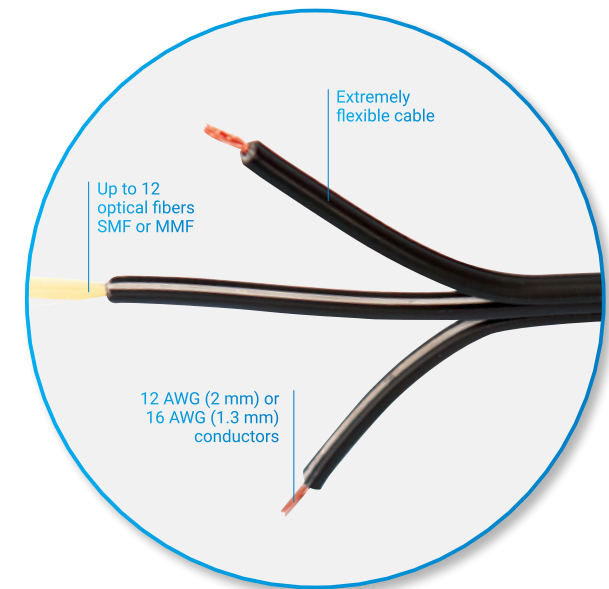

Direct System Selection Index

Splice Closures	Building Entrance Solutions	FACT Optical Distribution Frame	Propel XFrame	19" Splice Solutions	Singlemode Fiber Cables	Pre-term 19" Fiber	Pre-term FACT ODF Fiber	Fiber Optic Patch Cords	FiberGuide	Copper Category 6A	Cable Management & Overhead Racks	FiberREACH
-----------------	-----------------------------	---------------------------------	---------------	----------------------	-------------------------	--------------------	-------------------------	-------------------------	------------	--------------------	-----------------------------------	------------

Architecture System Selection Index

Colocation Campus and Building Infrastructure

Fiber Entrance, Meet-Me Room	High Fiber Count DC Interconnect	Campus Cabling	Building Cabling	Campus Cabling for Wi-Fi and Security
------------------------------	----------------------------------	----------------	------------------	---------------------------------------

Customer Space Cabling Infrastructure

Overview	MDA Fiber	ToR Fiber	EoR Copper	FiberGuide Raceway
----------	-----------	-----------	------------	--------------------

Reference Designs and Technical Information

MDA Cabinet	MDA Cross-connect 19"	MDA Cross-connect FACT ODF	IDF FACT	IDF 19"
-------------	-----------------------	----------------------------	----------	---------



Application overview

[Click here for the FiberREACH Solution Guide](#)

- Extends PoE distance:
 - Up to 4,600 m (7 W)
 - Up to 3,000 m (15 W)
 - Up to 1,800 m (30 W)
 - Up to 880 m (60 W)
 - Up to 350 m (90 W)
- Complete power and data solution platform for IP devices
- Low-voltage power provided by centralized source/backup UPS
- One power supply can drive up to 32 devices simultaneously
- Low-cost installation and setup
- Supports passive optical network (PON) applications
- Ideally suited to campus environments, airports, parking areas, stadiums, small cell base stations, fiber to the room and more

Not just 90 W up to 350 m, it's a new concept for PoE extenders

In developing the FiberREACH platform, SYSTIMAX engineers also improved the traditional PoE extender, especially for the highest current wattage (90 W) applications. The patented concept integrates voltage regulation, Ethernet, and a splice tray in a single enclosure designed for use with hybrid cable. It's ideal for emerging applications such as multiple lens and IR cameras, plus AI and IoT network edge architectures.

LAN switch

Fiber patch panel

Splice enclosure

48-57V DC power supply

Supports PON and NEC Class 2 power circuits

CommScope's FiberREACH cable

Fiber: singlemode or multimode

FR PoE Extender Small Cell

FR PoE Extender Wi-Fi AP

2 port FR PoE Extender Security Camera Security Camera

Direct System Selection Index

Splice Closures	Building Entrance Solutions	FACT Optical Distribution Frame	Propel XFrame	19" Splice Solutions	Singlemode Fiber Cables	Pre-term 19" Fiber	Pre-term FACT ODF Fiber	Fiber Optic Patch Cords	FiberGuide	Copper Category 6A	Cable Management & Overhead Racks	FiberREACH
-----------------	-----------------------------	---------------------------------	---------------	----------------------	-------------------------	--------------------	-------------------------	-------------------------	------------	--------------------	-----------------------------------	------------

Architecture System Selection Index

Colocation Campus and Building Infrastructure

Fiber Entrance, Meet-Me Room	High Fiber Count DC Interconnect	Campus Cabling	Building Cabling	Campus Cabling for Wi-Fi and Security
------------------------------	----------------------------------	----------------	------------------	---------------------------------------

Customer Space Cabling Infrastructure

Overview	MDA Fiber	ToR Fiber	EoR Copper	FiberGuide Raceway
----------	-----------	-----------	------------	--------------------

Reference Designs and Technical Information

MDA Cabinet	MDA Cross-connect 19"	MDA Cross-connect FACT ODF	IDF FACT	IDF 19"
-------------	-----------------------	----------------------------	----------	---------



Colocation Campus and Building Infrastructure

Overview

Fiber Entrance and Meet-Me Room

High Fiber Count DC Interconnect

Campus Cabling

Building Cabling

Campus Cabling for Wi-Fi and Security



Select a cabling section for more information.

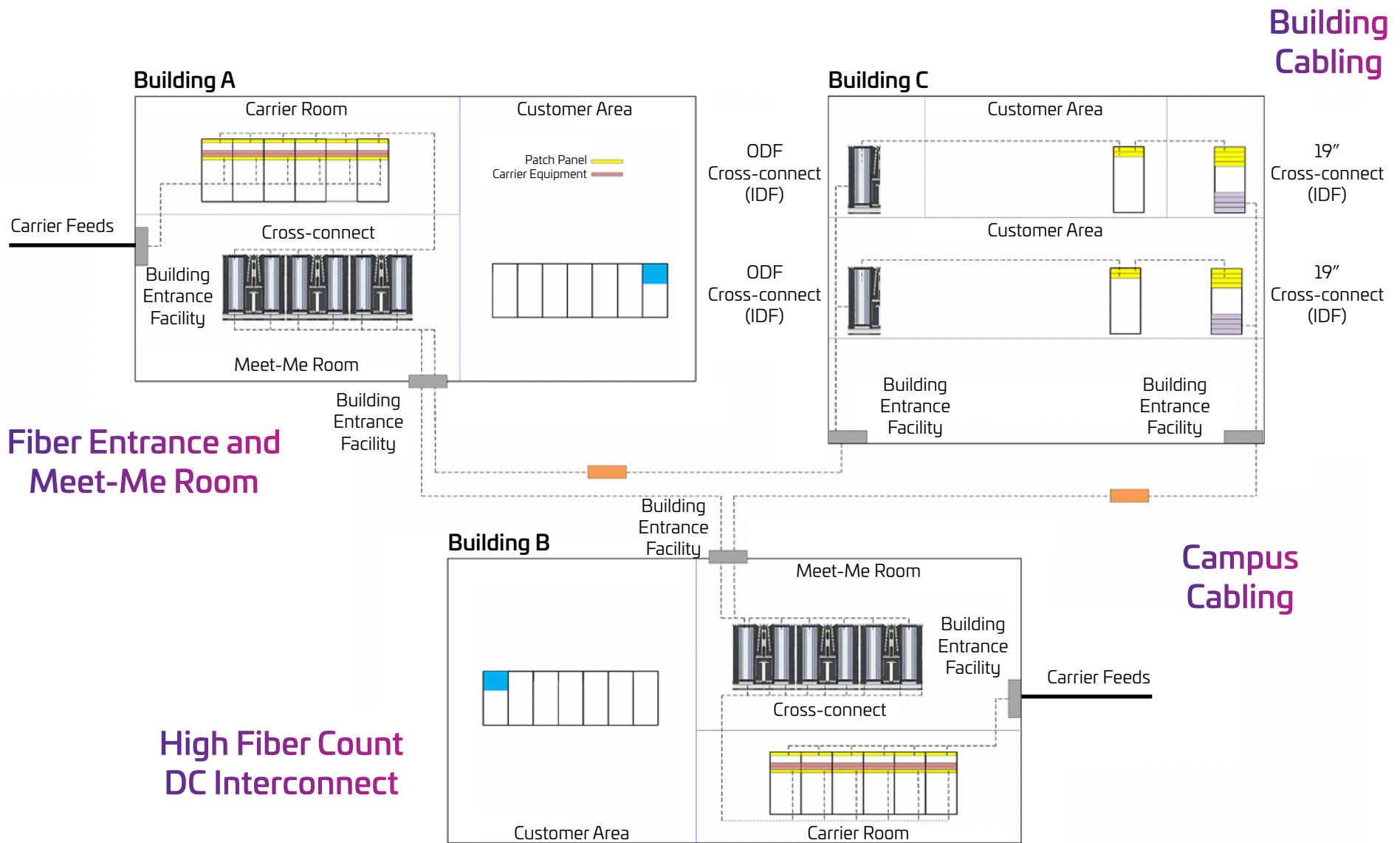

Fiber Entrance and Meet-Me Room

High Fiber Count DC Interconnect

Campus Cabling

Building Cabling

Direct System Selection Index

Splice Closures	Building Entrance Solutions	FACT Optical Distribution Frame	Propel XFrame	19" Splice Solutions	Singlemode Fiber Cables	Pre-term 19" Fiber	Pre-term FACT ODF Fiber	Fiber Optic Patch Cords	FiberGuide	Copper Category 6A	Cable Management & Overhead Racks	FiberREACH
-----------------	-----------------------------	---------------------------------	---------------	----------------------	-------------------------	--------------------	-------------------------	-------------------------	------------	--------------------	-----------------------------------	------------

Architecture System Selection Index

Colocation Campus and Building Infrastructure

Fiber Entrance, Meet-Me Room	High Fiber Count DC Interconnect	Campus Cabling	Building Cabling	Campus Cabling for Wi-Fi and Security
------------------------------	----------------------------------	----------------	------------------	---------------------------------------

Customer Space Cabling Infrastructure

XC Fiber	ToR Fiber	EoR Copper	FiberGuide Raceway
----------	-----------	------------	--------------------

Reference Designs and Technical Information

MDA Cabinet	MDA Cross-connect 19"	MDA Cross-connect FACT ODF	IDF FACT	IDF 19"
-------------	-----------------------	----------------------------	----------	---------



Select a product for more information.

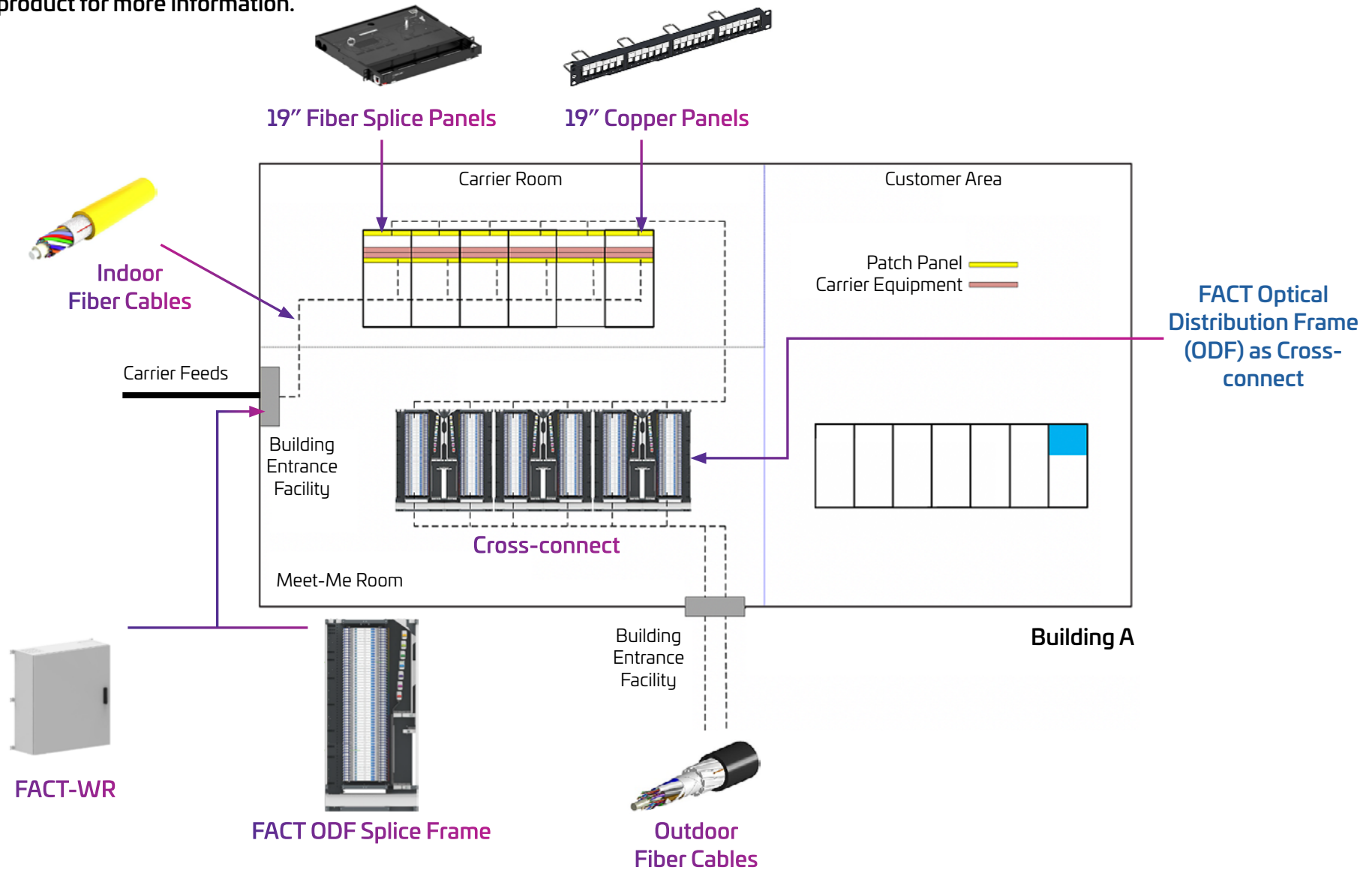

Direct System Selection Index

Splice Closures	Building Entrance Solutions	FACT Optical Distribution Frame	Propel XFrame	19" Splice Solutions	Singlemode Fiber Cables	Pre-term 19" Fiber	Pre-term FACT ODF Fiber	Fiber Optic Patch Cords	FiberGuide	Copper Category 6A	Cable Management & Overhead Racks	FiberREACH
-----------------	-----------------------------	---------------------------------	---------------	----------------------	-------------------------	--------------------	-------------------------	-------------------------	------------	--------------------	-----------------------------------	------------

Architecture System Selection Index

Colocation Campus and Building Infrastructure

Fiber Entrance, Meet-Me Room	High Fiber Count DC Interconnect	Campus Cabling	Building Cabling	Campus Cabling for Wi-Fi and Security
------------------------------	----------------------------------	----------------	------------------	---------------------------------------

Customer Space Cabling Infrastructure

XC Fiber	ToR Fiber	EoR Copper	FiberGuide Raceway
----------	-----------	------------	--------------------

Reference Designs and Technical Information

MDA Cabinet	MDA Cross-connect 19"	MDA Cross-connect FACT ODF	IDF FACT	IDF 19"
-------------	-----------------------	----------------------------	----------	---------



Select a product for more information.

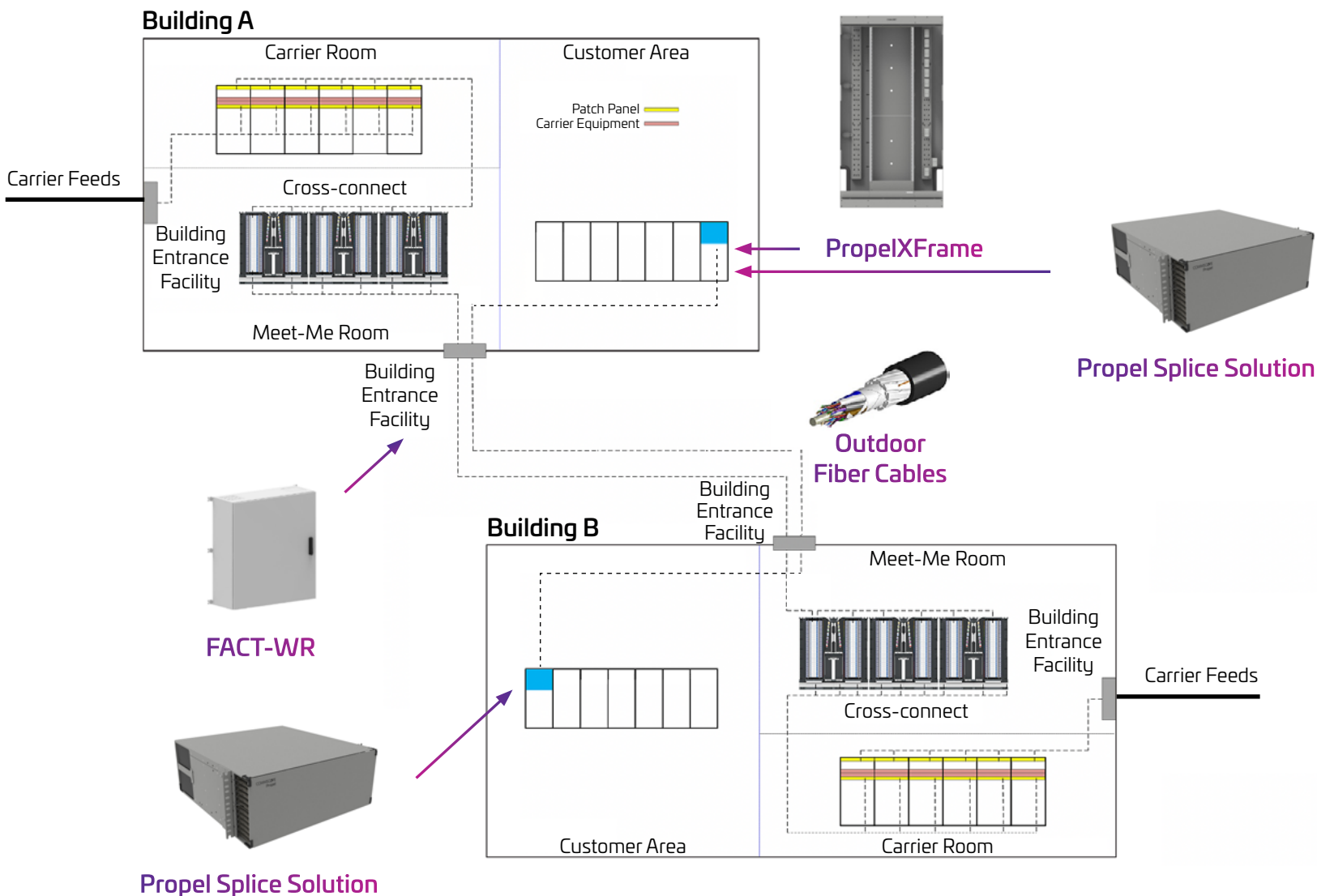

Direct System Selection Index

Splice Closures	Building Entrance Solutions	FACT Optical Distribution Frame	Propel XFrame	19" Splice Solutions	Singlemode Fiber Cables	Pre-term 19" Fiber	Pre-term FACT ODF Fiber	Fiber Optic Patch Cords	FiberGuide	Copper Category 6A	Cable Management & Overhead Racks	FiberREACH
-----------------	-----------------------------	---------------------------------	---------------	----------------------	-------------------------	--------------------	-------------------------	-------------------------	------------	--------------------	-----------------------------------	------------

Architecture System Selection Index

Colocation Campus and Building Infrastructure

Fiber Entrance, Meet-Me Room	High Fiber Count DC Interconnect	Campus Cabling	Building Cabling	Campus Cabling for Wi-Fi and Security
------------------------------	----------------------------------	----------------	------------------	---------------------------------------

Customer Space Cabling Infrastructure

XC Fiber	ToR Fiber	EoR Copper	FiberGuide Raceway
----------	-----------	------------	--------------------

Reference Designs and Technical Information

MDA Cabinet	MDA Cross-connect 19"	MDA Cross-connect FACT ODF	IDF FACT	IDF 19"
-------------	-----------------------	----------------------------	----------	---------



Select a product for more information.

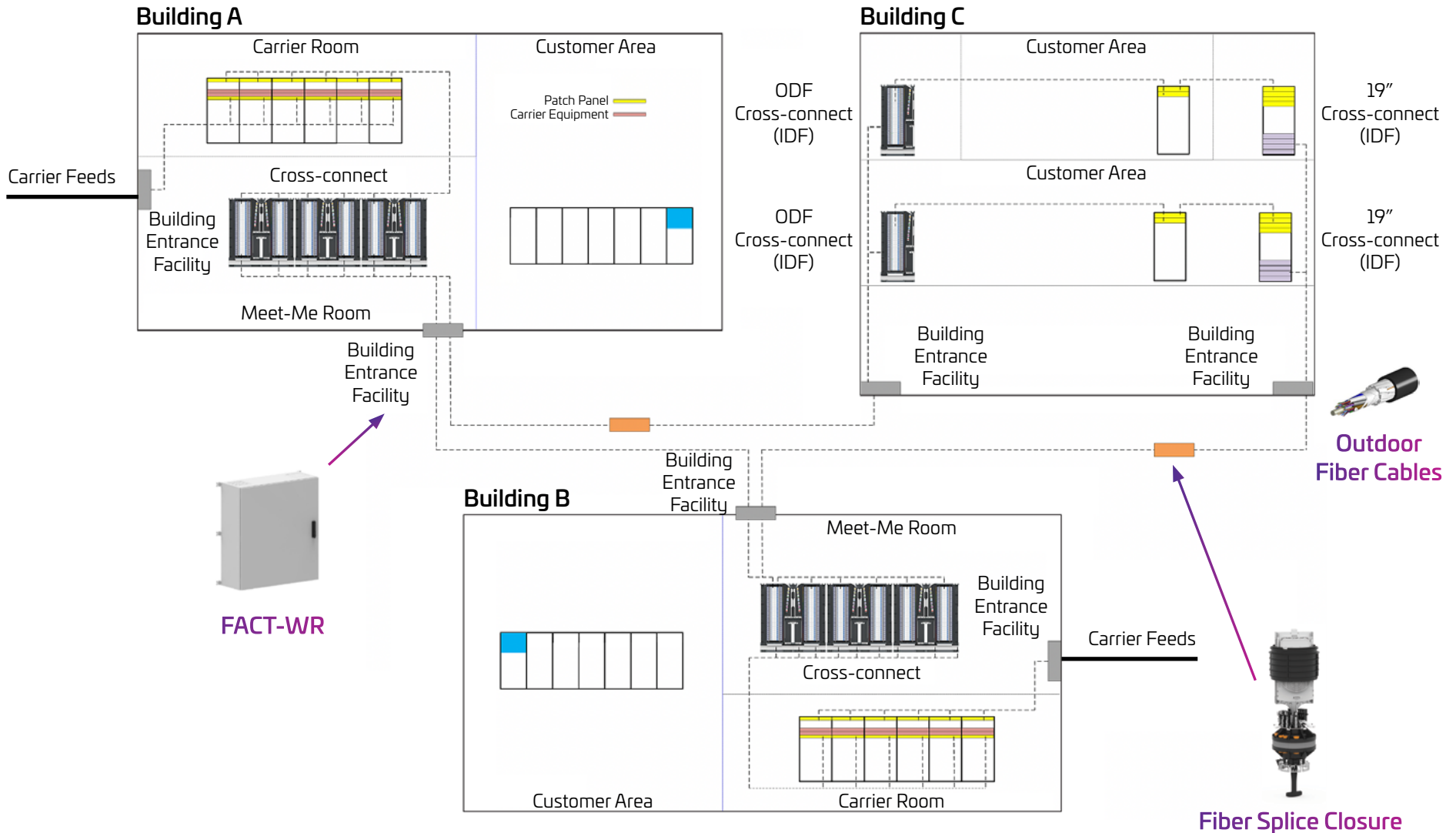

Direct System Selection Index

Splice Closures	Building Entrance Solutions	FACT Optical Distribution Frame	Propel XFrame	19" Splice Solutions	Singlemode Fiber Cables	Pre-term 19" Fiber	Pre-term FACT ODF Fiber	Fiber Optic Patch Cords	FiberGuide	Copper Category 6A	Cable Management & Overhead Racks	FiberREACH
-----------------	-----------------------------	---------------------------------	---------------	----------------------	-------------------------	--------------------	-------------------------	-------------------------	------------	--------------------	-----------------------------------	------------

Architecture System Selection Index

Colocation Campus and Building Infrastructure

Fiber Entrance, Meet-Me Room	High Fiber Count DC Interconnect	Campus Cabling	Building Cabling	Campus Cabling for Wi-Fi and Security
------------------------------	----------------------------------	----------------	------------------	---------------------------------------

Customer Space Cabling Infrastructure

XC Fiber	ToR Fiber	EoR Copper	FiberGuide Raceway
----------	-----------	------------	--------------------

Reference Designs and Technical Information

MDA Cabinet	MDA Cross-connect 19"	MDA Cross-connect FACT ODF	IDF FACT	IDF 19"
-------------	-----------------------	----------------------------	----------	---------



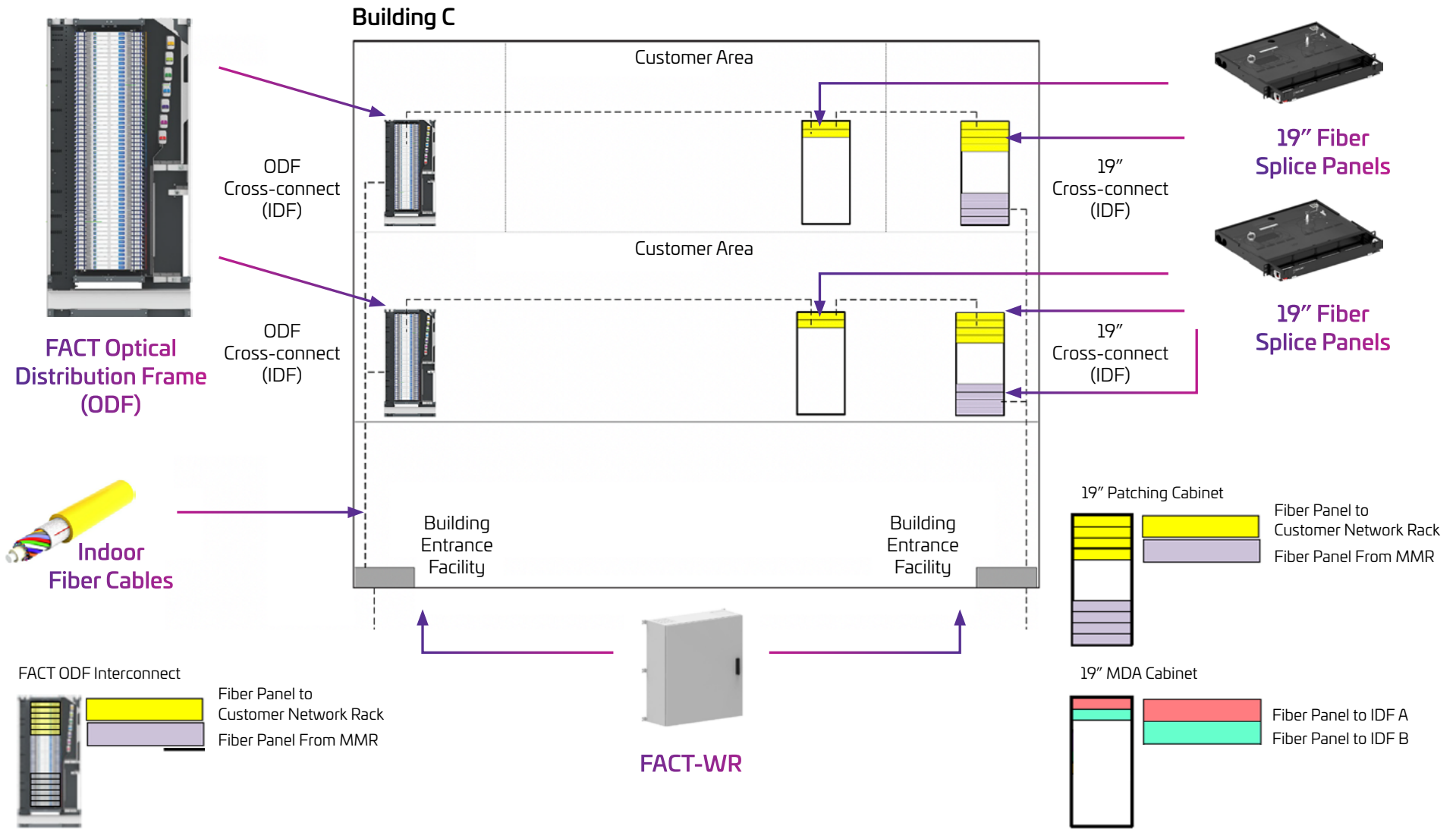

Direct System Selection Index

Splice Closures	Building Entrance Solutions	FACT Optical Distribution Frame	Propel XFrame	19" Splice Solutions	Singlemode Fiber Cables	Pre-term 19" Fiber	Pre-term FACT ODF Fiber	Fiber Optic Patch Cords	FiberGuide	Copper Category 6A	Cable Management & Overhead Racks	FiberREACH
-----------------	-----------------------------	---------------------------------	---------------	----------------------	-------------------------	--------------------	-------------------------	-------------------------	------------	--------------------	-----------------------------------	------------

Architecture System Selection Index

Colocation Campus and Building Infrastructure

Fiber Entrance, Meet-Me Room	High Fiber Count DC Interconnect	Campus Cabling	Building Cabling	Campus Cabling for Wi-Fi and Security
------------------------------	----------------------------------	----------------	------------------	---------------------------------------

Customer Space Cabling Infrastructure

XC Fiber	ToR Fiber	EoR Copper	FiberGuide Raceway
----------	-----------	------------	--------------------

Reference Designs and Technical Information

MDA Cabinet	MDA Cross-connect 19"	MDA Cross-connect FACT ODF	IDF FACT	IDF 19"
-------------	-----------------------	----------------------------	----------	---------



Select a product for more information.

FACT IDF to Customer Cage: Splice Scenario

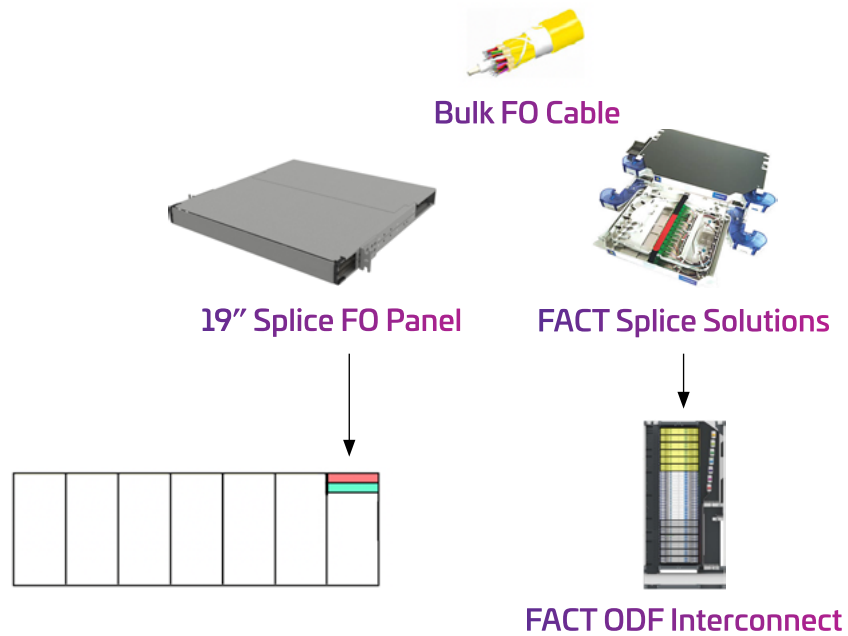

FACT IDF to Customer Cage: MPO Pre-terminated Scenario

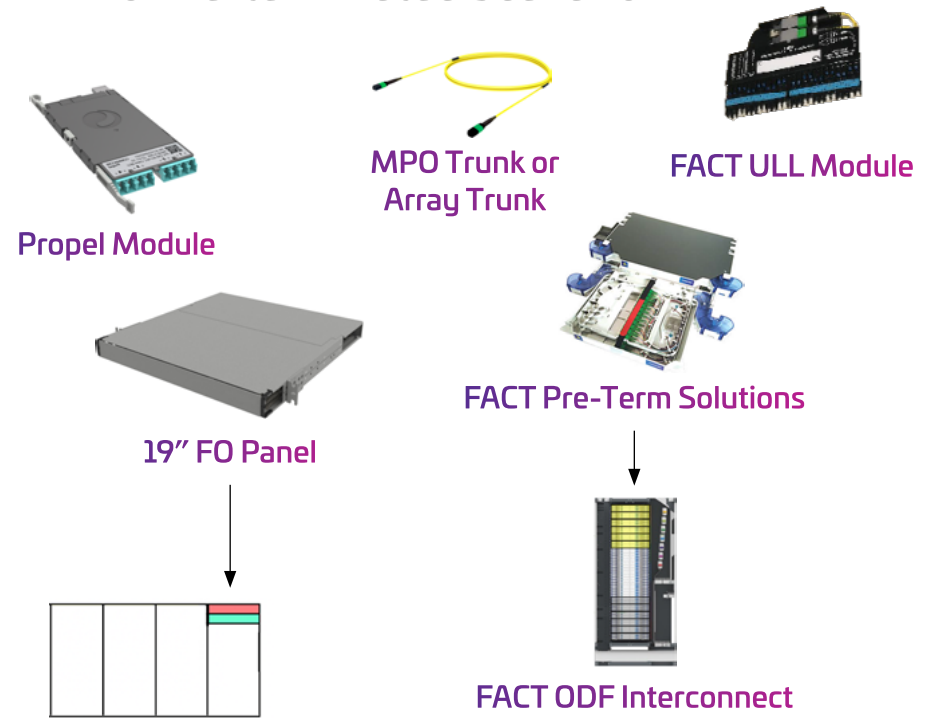

Direct System Selection Index

Splice Closures	Building Entrance Solutions	FACT Optical Distribution Frame	Propel XFrame	19" Splice Solutions	Singlemode Fiber Cables	Pre-term 19" Fiber	Pre-term FACT ODF Fiber	Fiber Optic Patch Cords	FiberGuide	Copper Category 6A	Cable Management & Overhead Racks	FiberREACH
-----------------	-----------------------------	---------------------------------	---------------	----------------------	-------------------------	--------------------	-------------------------	-------------------------	------------	--------------------	-----------------------------------	------------

Architecture System Selection Index

Colocation Campus and Building Infrastructure

Fiber Entrance, Meet-Me Room	High Fiber Count DC Interconnect	Campus Cabling	Building Cabling	Campus Cabling for Wi-Fi and Security
------------------------------	----------------------------------	----------------	------------------	---------------------------------------

Customer Space Cabling Infrastructure

XC Fiber	ToR Fiber	EoR Copper	FiberGuide Raceway
----------	-----------	------------	--------------------

Reference Designs and Technical Information

MDA Cabinet	MDA Cross-connect 19"	MDA Cross-connect FACT ODF	IDF FACT	IDF 19"
-------------	-----------------------	----------------------------	----------	---------



Select a product for more information.

19" IDF to Customer Cage: Splice Scenario

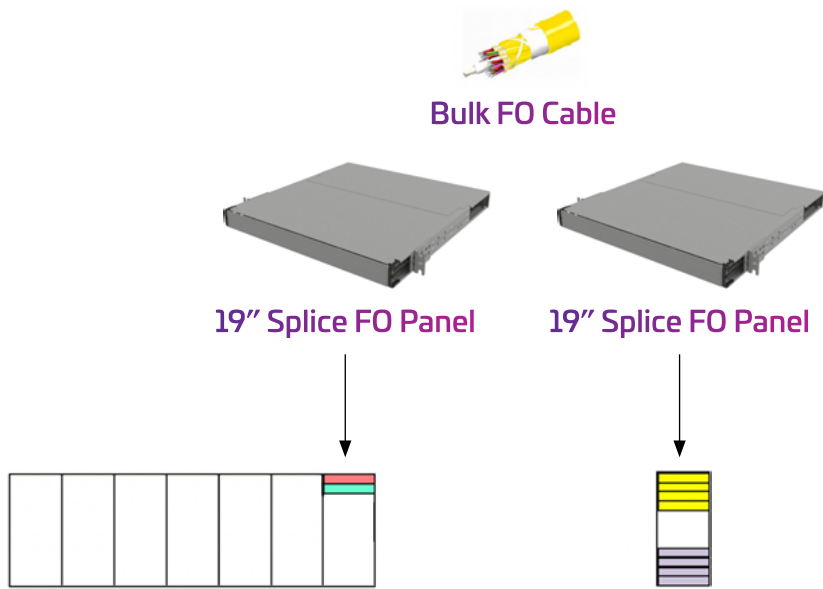

19" IDF to Customer Cage: MPO Pre-terminated Scenario

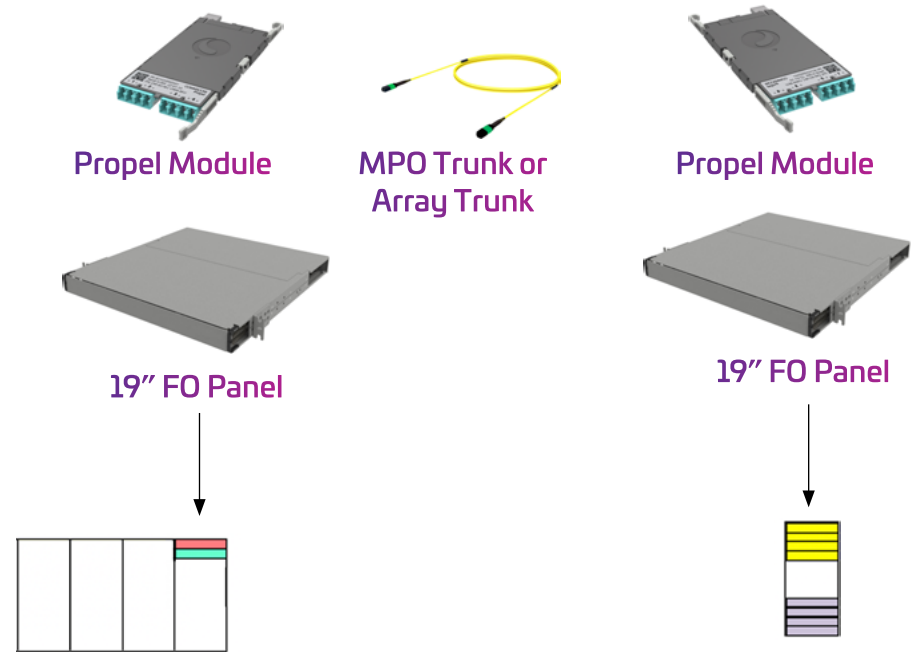

Direct System Selection Index

Splice Closures	Building Entrance Solutions	FACT Optical Distribution Frame	Propel XFrame	19" Splice Solutions	Singlemode Fiber Cables	Pre-term 19" Fiber	Pre-term FACT ODF Fiber	Fiber Optic Patch Cords	FiberGuide	Copper Category 6A	Cable Management & Overhead Racks	FiberREACH
-----------------	-----------------------------	---------------------------------	---------------	----------------------	-------------------------	--------------------	-------------------------	-------------------------	------------	--------------------	-----------------------------------	------------

Architecture System Selection Index

Colocation Campus and Building Infrastructure

Fiber Entrance, Meet-Me Room	High Fiber Count DC Interconnect	Campus Cabling	Building Cabling	Campus Cabling for Wi-Fi and Security
------------------------------	----------------------------------	----------------	------------------	---------------------------------------

Customer Space Cabling Infrastructure

XC Fiber	ToR Fiber	EoR Copper	FiberGuide Raceway
----------	-----------	------------	--------------------

Reference Designs and Technical Information

MDA Cabinet	MDA Cross-connect 19"	MDA Cross-connect FACT ODF	IDF FACT	IDF 19"
-------------	-----------------------	----------------------------	----------	---------



Select a product for more information.

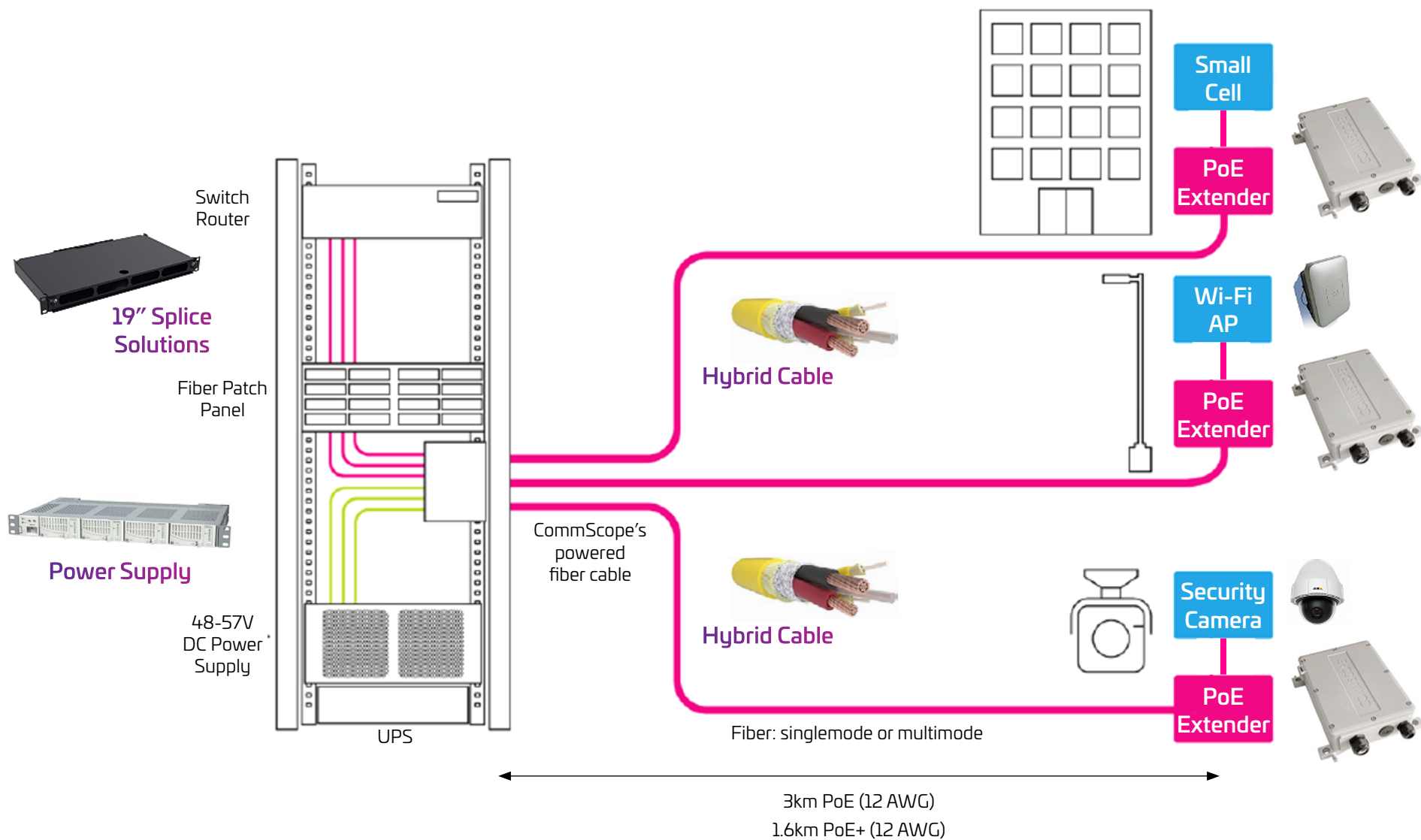

Direct System Selection Index

Splice Closures	Building Entrance Solutions	FACT Optical Distribution Frame	Propel XFrame	19" Splice Solutions	Singlemode Fiber Cables	Pre-term 19" Fiber	Pre-term FACT ODF Fiber	Fiber Optic Patch Cords	FiberGuide	Copper Category 6A	Cable Management & Overhead Racks	FiberREACH
-----------------	-----------------------------	---------------------------------	---------------	----------------------	-------------------------	--------------------	-------------------------	-------------------------	------------	--------------------	-----------------------------------	------------

Architecture System Selection Index

Colocation Campus and Building Infrastructure

Fiber Entrance, Meet-Me Room	High Fiber Count DC Interconnect	Campus Cabling	Building Cabling	Campus Cabling for Wi-Fi and Security
------------------------------	----------------------------------	----------------	------------------	---------------------------------------

Customer Space Cabling Infrastructure

XC Fiber	ToR Fiber	EoR Copper	FiberGuide Raceway
----------	-----------	------------	--------------------

Reference Designs and Technical Information

MDA Cabinet	MDA Cross-connect 19"	MDA Cross-connect FACT ODF	IDF FACT	IDF 19"
-------------	-----------------------	----------------------------	----------	---------



Customer Space Cabling Infrastructure

- Main Distribution Area (MDA) Fiber
- Equipment Distribution Area (EDA) Fiber
- Equipment Distribution Area (EDA) Copper
- FiberGuide Raceway Systems



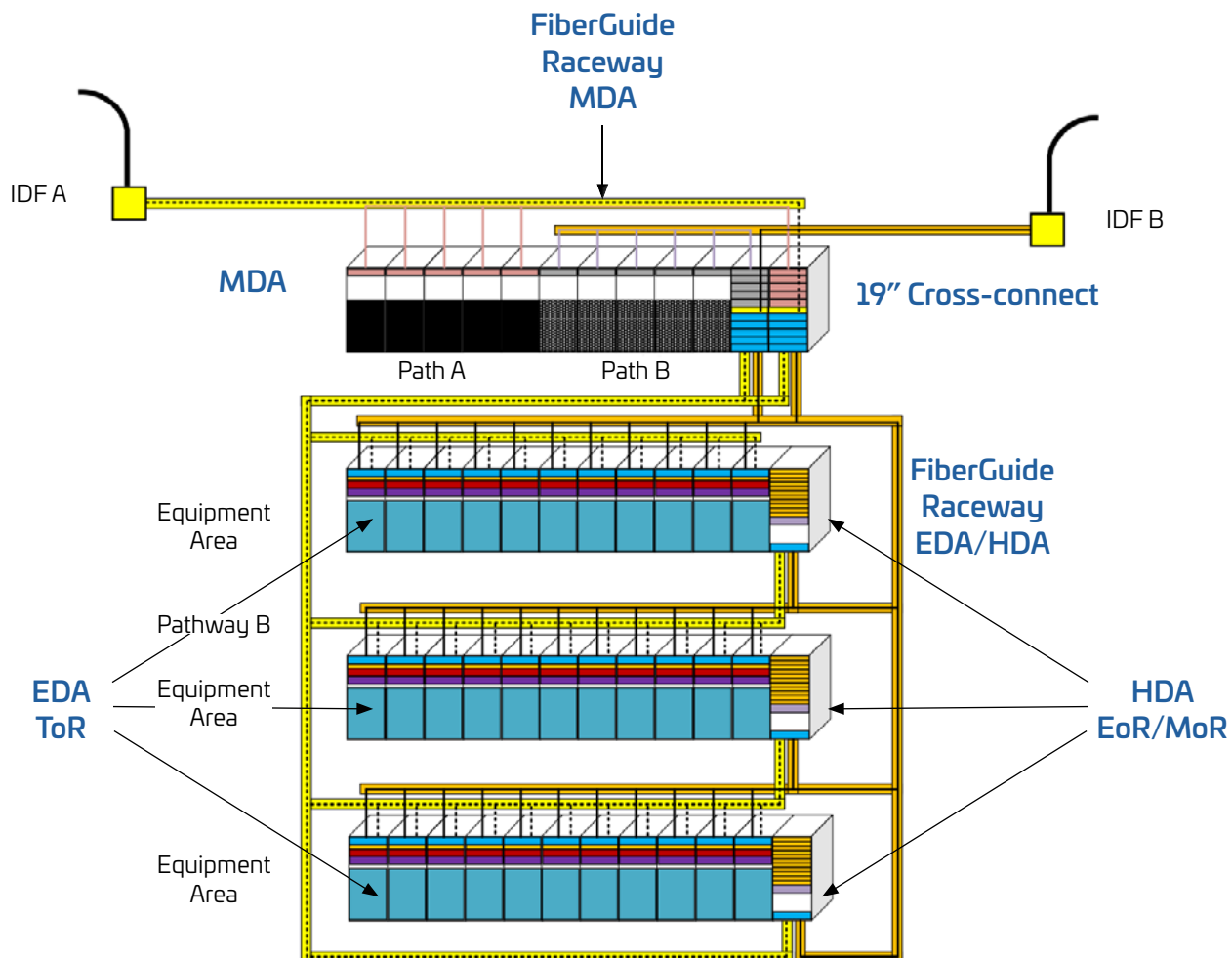
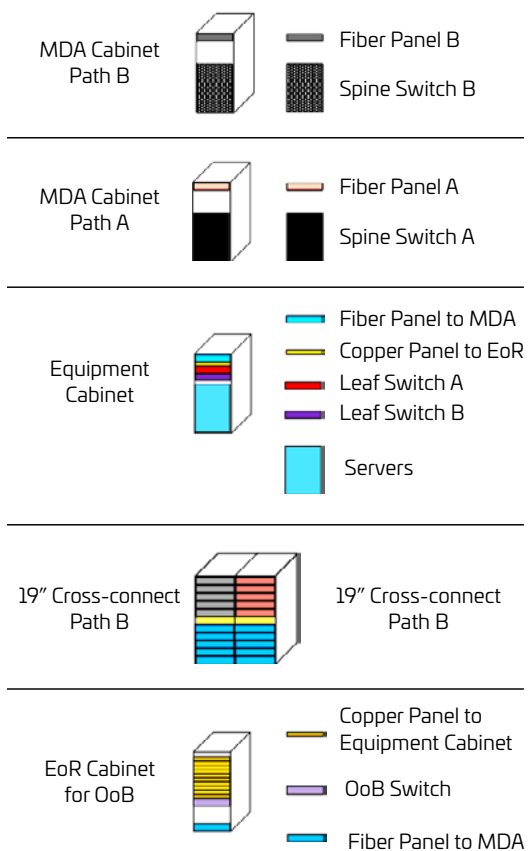

Click on an area text to see solution

Direct System Selection Index

Splice Closures	Building Entrance Solutions	FACT Optical Distribution Frame	Propel XFrame	19" Splice Solutions	Singlemode Fiber Cables	Pre-term 19" Fiber	Pre-term FACT ODF Fiber	Fiber Optic Patch Cords	FiberGuide	Copper Category 6A	Cable Management & Overhead Racks	FiberREACH
-----------------	-----------------------------	---------------------------------	---------------	----------------------	-------------------------	--------------------	-------------------------	-------------------------	------------	--------------------	-----------------------------------	------------

Architecture System Selection Index

Colocation Campus and Building Infrastructure

Fiber Entrance, Meet-Me Room	High Fiber Count DC Interconnect	Campus Cabling	Building Cabling	Campus Cabling for Wi-Fi and Security
------------------------------	----------------------------------	----------------	------------------	---------------------------------------

Customer Space Cabling Infrastructure

XC Fiber	ToR Fiber	EoR Copper	FiberGuide Raceway
----------	-----------	------------	--------------------

Reference Designs and Technical Information

MDA Cabinet	MDA Cross-connect 19"	MDA Cross-connect FACT ODF	IDF FACT	IDF 19"
-------------	-----------------------	----------------------------	----------	---------

Select a product for more information.

MDA Cabling Channel 19" XC

MDA Cabling Channel ODF XC

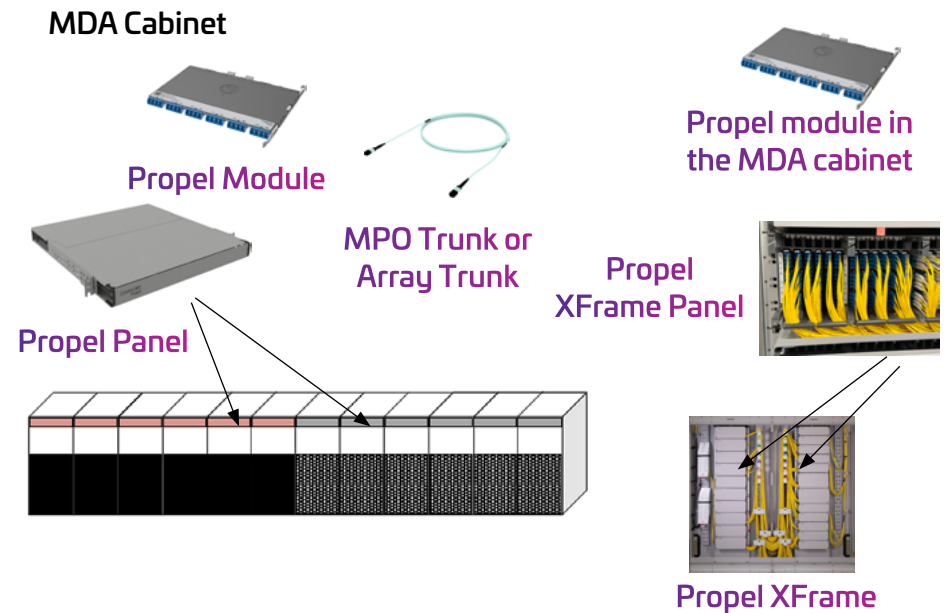
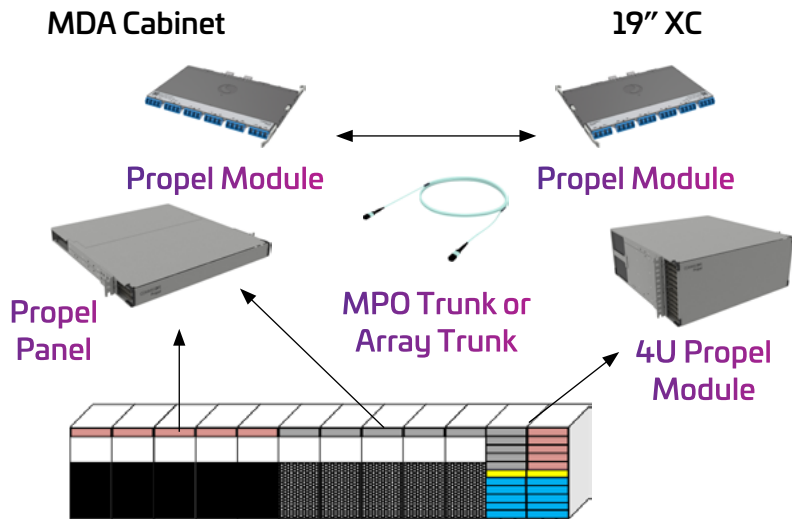

Direct System Selection Index

Splice Closures	Building Entrance Solutions	FACT Optical Distribution Frame	Propel XFrame	19" Splice Solutions	Singlemode Fiber Cables	Pre-term 19" Fiber	Pre-term FACT ODF Fiber	Fiber Optic Patch Cords	FiberGuide	Copper Category 6A	Cable Management & Overhead Racks	FiberREACH
-----------------	-----------------------------	---------------------------------	---------------	----------------------	-------------------------	--------------------	-------------------------	-------------------------	------------	--------------------	-----------------------------------	------------

Architecture System Selection Index

Colocation Campus and Building Infrastructure

Fiber Entrance, Meet-Me Room	High Fiber Count DC Interconnect	Campus Cabling	Building Cabling	Campus Cabling for Wi-Fi and Security
------------------------------	----------------------------------	----------------	------------------	---------------------------------------

Customer Space Cabling Infrastructure

XC Fiber	ToR Fiber	EoR Copper	FiberGuide Raceway
----------	-----------	------------	--------------------

Reference Designs and Technical Information

MDA Cabinet	MDA Cross-connect 19"	MDA Cross-connect FACT ODF	IDF FACT	IDF 19"
-------------	-----------------------	----------------------------	----------	---------



Select a product for more information.

Equipment Cabinet

Propel Fiber Panel

Propel XFrame Panel

EPX Fiber Panel
OoB Copper Panel
ToR Switch Path A
ToR Switch Path B

EPX - G2 Style

Propel-1U Fiber Panel
OoB Copper Panel
ToR Switch Path A
ToR Switch Path B

Propel

Mixed Media Panel
ToR Switch Path A
ToR Switch Path B

Mixed Media Basic

The Mixed Media Panel allows the use of copper and fiber connectivity in the same panel.

Direct System Selection Index

Splice Closures	Building Entrance Solutions	FACT Optical Distribution Frame	Propel XFrame	19" Splice Solutions	Singlemode Fiber Cables	Pre-term 19" Fiber	Pre-term FACT ODF Fiber	Fiber Optic Patch Cords	FiberGuide	Copper Category 6A	Cable Management & Overhead Racks	FiberREACH
-----------------	-----------------------------	---------------------------------	---------------	----------------------	-------------------------	--------------------	-------------------------	-------------------------	------------	--------------------	-----------------------------------	------------

Architecture System Selection Index

Colocation Campus and Building Infrastructure

Fiber Entrance, Meet-Me Room	High Fiber Count DC Interconnect	Campus Cabling	Building Cabling	Campus Cabling for Wi-Fi and Security
------------------------------	----------------------------------	----------------	------------------	---------------------------------------

Customer Space Cabling Infrastructure

XC Fiber	ToR Fiber	EoR Copper	FiberGuide Raceway
----------	-----------	------------	--------------------

Reference Designs and Technical Information

MDA Cabinet	MDA Cross-connect 19"	MDA Cross-connect FACT ODF	IDF FACT	IDF 19"
-------------	-----------------------	----------------------------	----------	---------



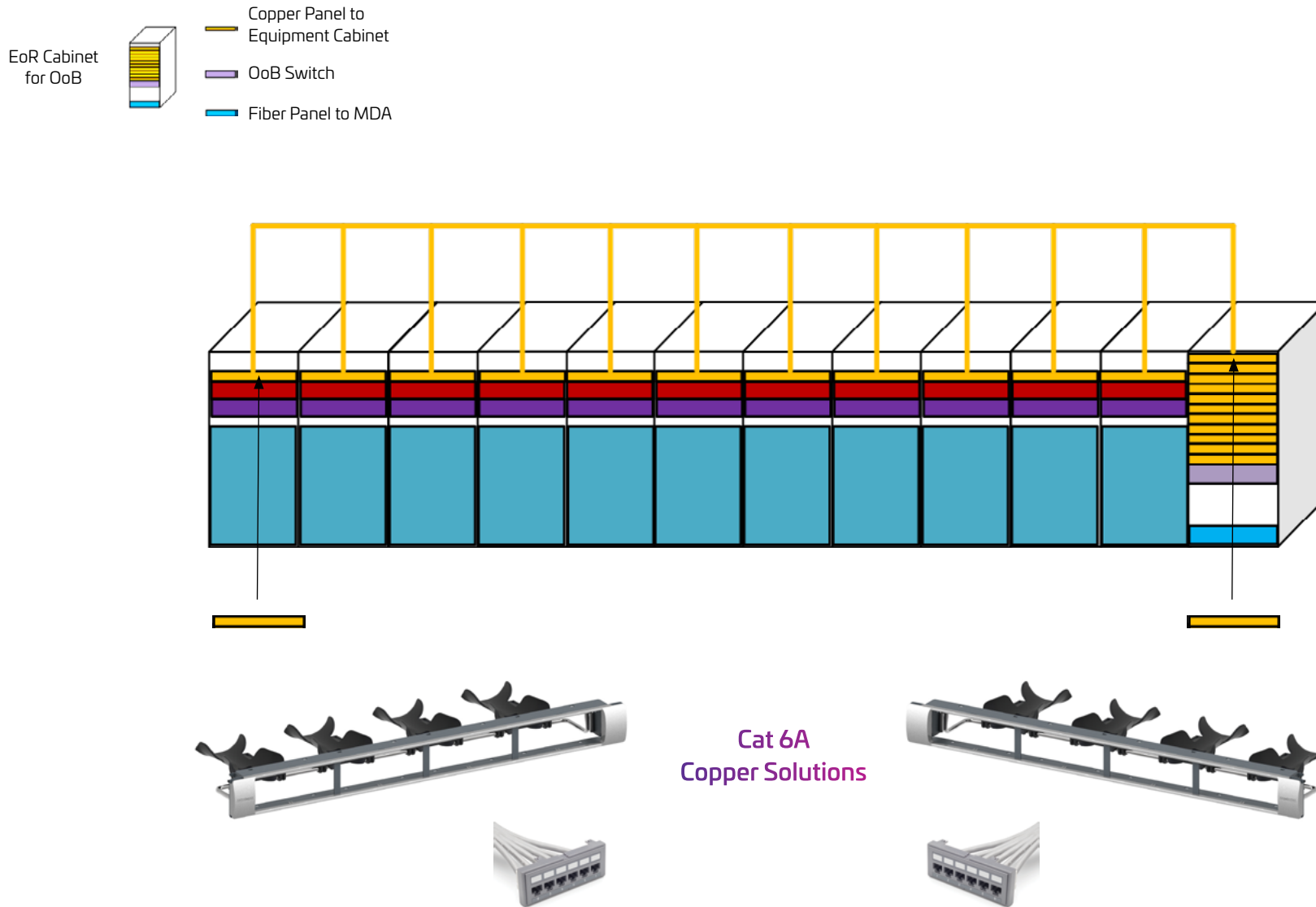

Direct System Selection Index

Splice Closures	Building Entrance Solutions	FACT Optical Distribution Frame	Propel XFrame	19" Splice Solutions	Singlemode Fiber Cables	Pre-term 19" Fiber	Pre-term FACT ODF Fiber	Fiber Optic Patch Cords	FiberGuide	Copper Category 6A	Cable Management & Overhead Racks	FiberREACH
-----------------	-----------------------------	---------------------------------	---------------	----------------------	-------------------------	--------------------	-------------------------	-------------------------	------------	--------------------	-----------------------------------	------------

Architecture System Selection Index

Colocation Campus and Building Infrastructure

Fiber Entrance, Meet-Me Room	High Fiber Count DC Interconnect	Campus Cabling	Building Cabling	Campus Cabling for Wi-Fi and Security
------------------------------	----------------------------------	----------------	------------------	---------------------------------------

Customer Space Cabling Infrastructure

XC Fiber	ToR Fiber	EoR Copper	FiberGuide Raceway
----------	-----------	------------	--------------------

Reference Designs and Technical Information

MDA Cabinet	MDA Cross-connect 19"	MDA Cross-connect FACT ODF	IDF FACT	IDF 19"
-------------	-----------------------	----------------------------	----------	---------



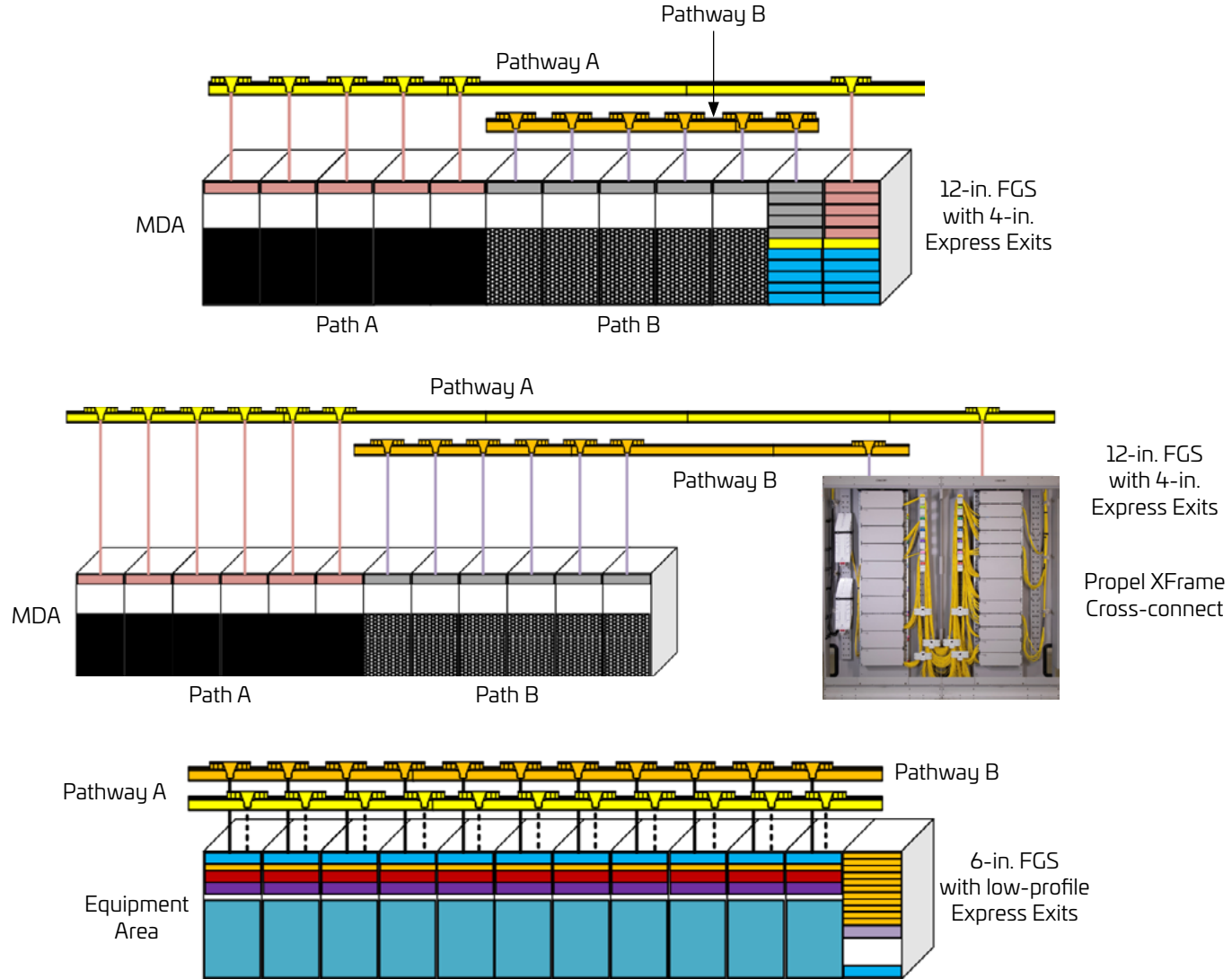

Direct System Selection Index

Splice Closures	Building Entrance Solutions	FACT Optical Distribution Frame	Propel XFrame	19" Splice Solutions	Singlemode Fiber Cables	Pre-term 19" Fiber	Pre-term FACT ODF Fiber	Fiber Optic Patch Cords	FiberGuide	Copper Category 6A	Cable Management & Overhead Racks	FiberREACH
-----------------	-----------------------------	---------------------------------	---------------	----------------------	-------------------------	--------------------	-------------------------	-------------------------	------------	--------------------	-----------------------------------	------------

Architecture System Selection Index

Colocation Campus and Building Infrastructure

Fiber Entrance, Meet-Me Room	High Fiber Count DC Interconnect	Campus Cabling	Building Cabling	Campus Cabling for Wi-Fi and Security
------------------------------	----------------------------------	----------------	------------------	---------------------------------------

Customer Space Cabling Infrastructure

XC Fiber	ToR Fiber	EoR Copper	FiberGuide Raceway
----------	-----------	------------	--------------------

Reference Designs and Technical Information

MDA Cabinet	MDA Cross-connect 19"	MDA Cross-connect FACT ODF	IDF FACT	IDF 19"
-------------	-----------------------	----------------------------	----------	---------



Reference Designs and Technical Information

MDA Cabinet

MDA Cross-connect 19"

MDA Cross-connect FACT ODF

IDF FACT

IDF 19"



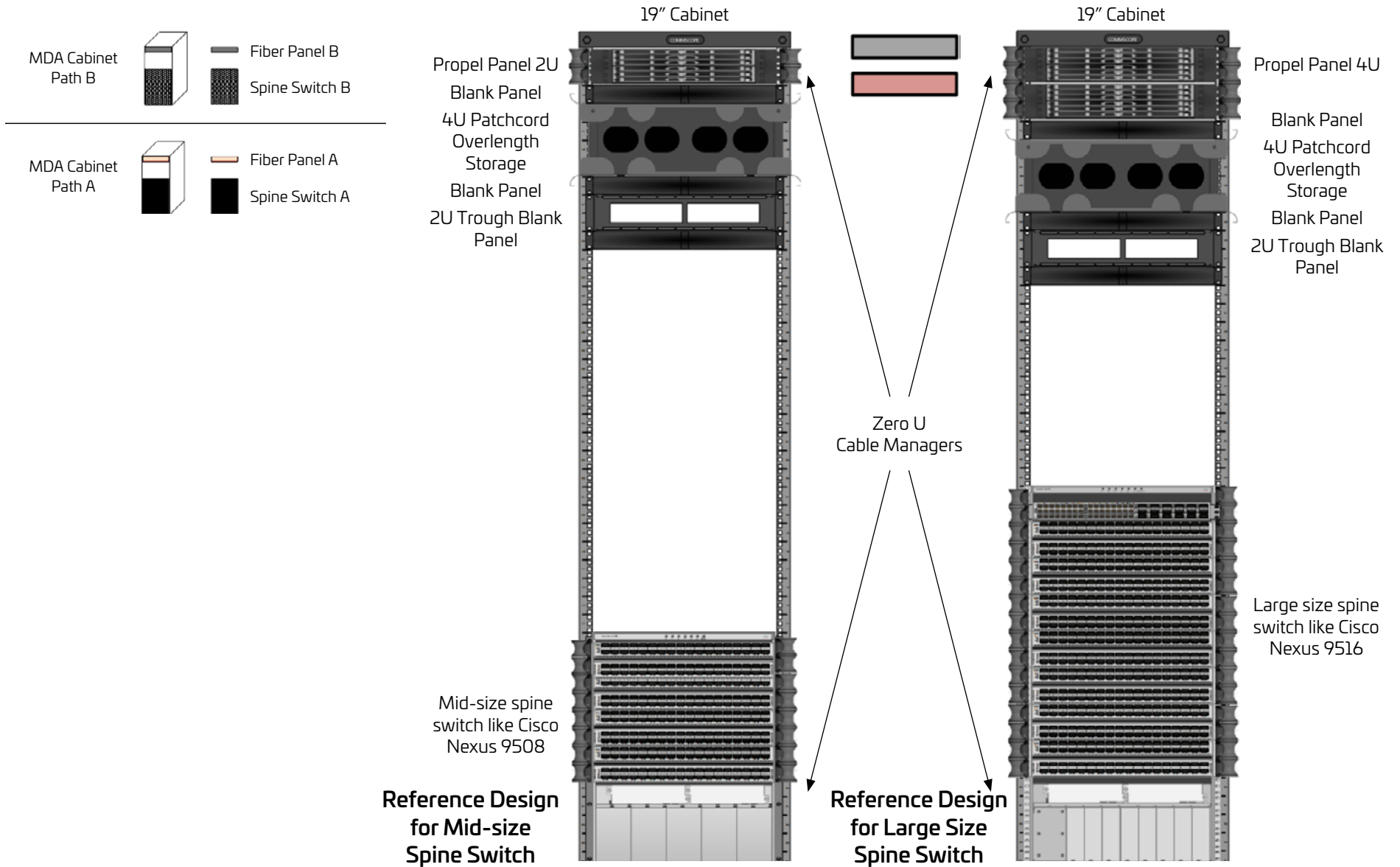

Direct System Selection Index

Splice Closures	Building Entrance Solutions	FACT Optical Distribution Frame	Propel XFrame	19" Splice Solutions	Singlemode Fiber Cables	Pre-term 19" Fiber	Pre-term FACT ODF Fiber	Fiber Optic Patch Cords	FiberGuide	Copper Category 6A	Cable Management & Overhead Racks	FiberREACH
-----------------	-----------------------------	---------------------------------	---------------	----------------------	-------------------------	--------------------	-------------------------	-------------------------	------------	--------------------	-----------------------------------	------------

Architecture System Selection Index

Colocation Campus and Building Infrastructure

Fiber Entrance, Meet-Me Room	High Fiber Count DC Interconnect	Campus Cabling	Building Cabling	Campus Cabling for Wi-Fi and Security
------------------------------	----------------------------------	----------------	------------------	---------------------------------------

Customer Space Cabling Infrastructure

XC Fiber	ToR Fiber	EoR Copper	FiberGuide Raceway
----------	-----------	------------	--------------------

Reference Designs and Technical Information

MDA Cabinet	MDA Cross-connect 19"	MDA Cross-connect FACT ODF	IDF FACT	IDF 19"
-------------	-----------------------	----------------------------	----------	---------



19" Cross-connect Path B



19" Cross-connect Path B

19" Cabinet

3 x Propel Panels 4U
Patch section 1

Blank Panel

Overlength Storage 4U

Blank Panel

3 x Propel Panels 4U
Patch Section 2

Blank Panel

Overlength Storage 4U

Blank Panel

Cable Trough 2U to guide patch cords to adjacent cabinets

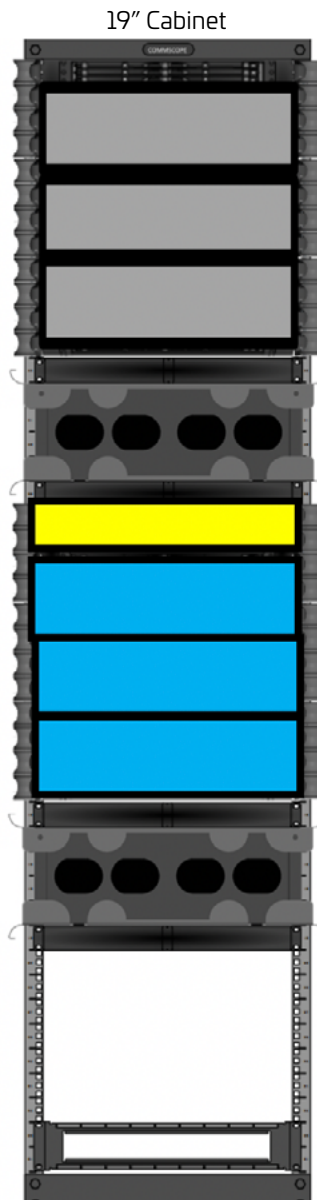

19" Cabinet

3 x Propel Panels 4U
Patch section 1

Blank Panel

Overlength Storage 4U

Blank Panel

3 x Propel Panels 4U
Patch Section 2

Blank Panel

Overlength Storage 4U

Blank Panel

Cable Trough 2U to guide patch cords to adjacent cabinets

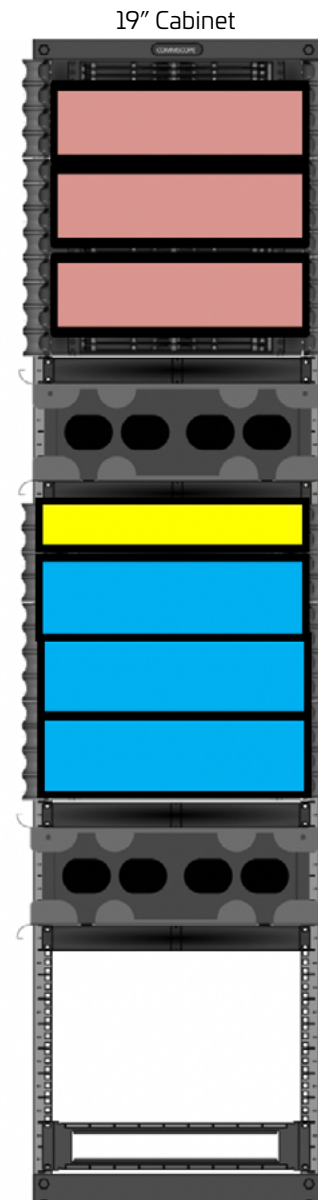

Direct System Selection Index

Splice Closures	Building Entrance Solutions	FACT Optical Distribution Frame	Propel XFrame	19" Splice Solutions	Singlemode Fiber Cables	Pre-term 19" Fiber	Pre-term FACT ODF Fiber	Fiber Optic Patch Cords	FiberGuide	Copper Category 6A	Cable Management & Overhead Racks	FiberREACH
-----------------	-----------------------------	---------------------------------	---------------	----------------------	-------------------------	--------------------	-------------------------	-------------------------	------------	--------------------	-----------------------------------	------------

Architecture System Selection Index

Colocation Campus and Building Infrastructure

Fiber Entrance, Meet-Me Room	High Fiber Count DC Interconnect	Campus Cabling	Building Cabling	Campus Cabling for Wi-Fi and Security
------------------------------	----------------------------------	----------------	------------------	---------------------------------------

Customer Space Cabling Infrastructure

XC Fiber	ToR Fiber	EoR Copper	FiberGuide Raceway
----------	-----------	------------	--------------------

Reference Designs and Technical Information

MDA Cabinet	MDA Cross-connect 19"	MDA Cross-connect FACT ODF	IDF FACT	IDF 19"
-------------	-----------------------	----------------------------	----------	---------



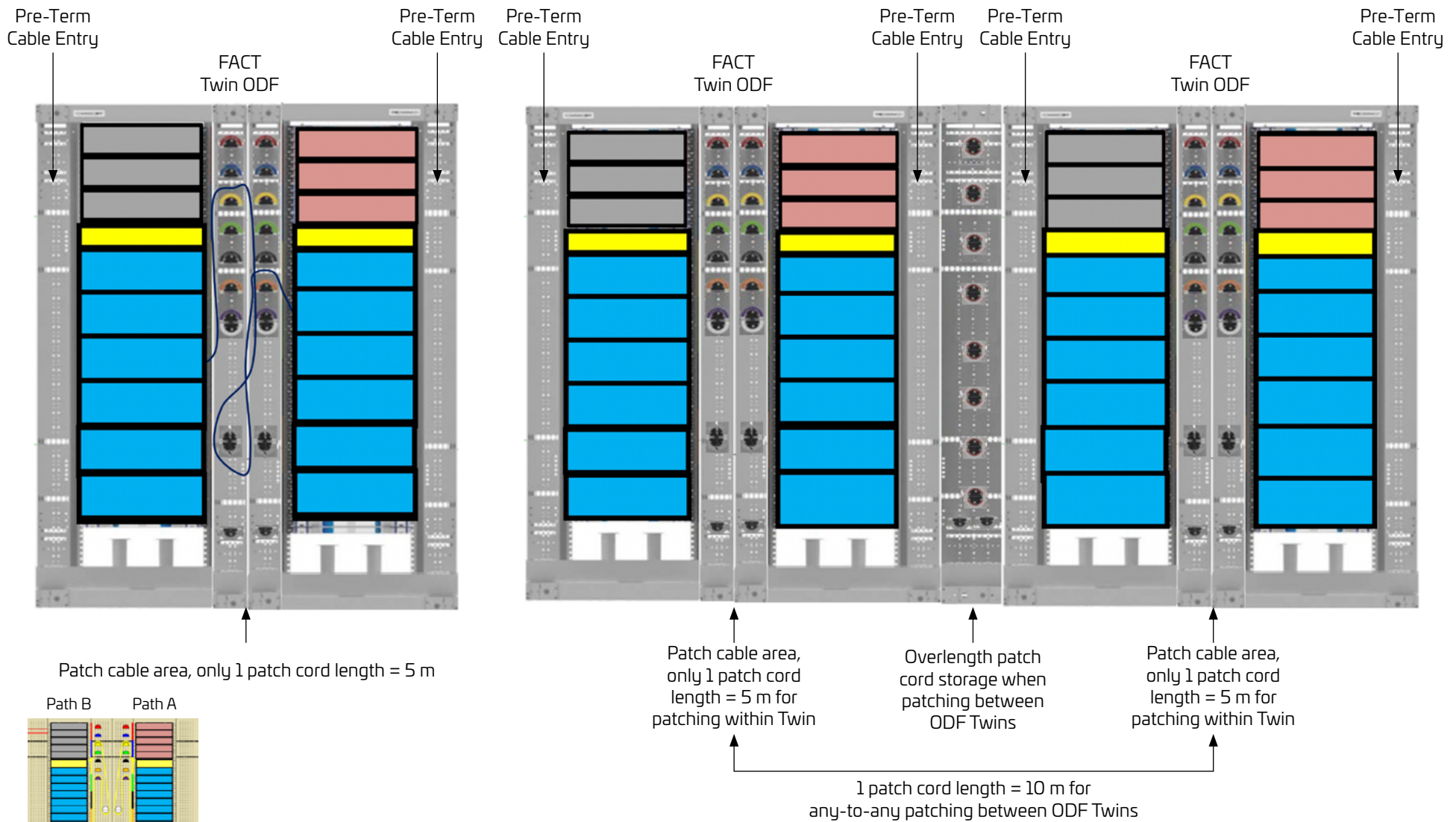

Note: The XC can consist of more than 4 cabinets depending on the DC size.

Direct System Selection Index

Splice Closures	Building Entrance Solutions	FACT Optical Distribution Frame	Propel XFrame	19" Splice Solutions	Singlemode Fiber Cables	Pre-term 19" Fiber	Pre-term FACT ODF Fiber	Fiber Optic Patch Cords	FiberGuide	Copper Category 6A	Cable Management & Overhead Racks	FiberREACH
-----------------	-----------------------------	---------------------------------	---------------	----------------------	-------------------------	--------------------	-------------------------	-------------------------	------------	--------------------	-----------------------------------	------------

Architecture System Selection Index

Colocation Campus and Building Infrastructure

Fiber Entrance, Meet-Me Room	High Fiber Count DC Interconnect	Campus Cabling	Building Cabling	Campus Cabling for Wi-Fi and Security
------------------------------	----------------------------------	----------------	------------------	---------------------------------------

Customer Space Cabling Infrastructure

XC Fiber	ToR Fiber	EoR Copper	FiberGuide Raceway
----------	-----------	------------	--------------------

Reference Designs and Technical Information

MDA Cabinet	MDA Cross-connect 19"	MDA Cross-connect FACT ODF	IDF FACT	IDF 19"
-------------	-----------------------	----------------------------	----------	---------



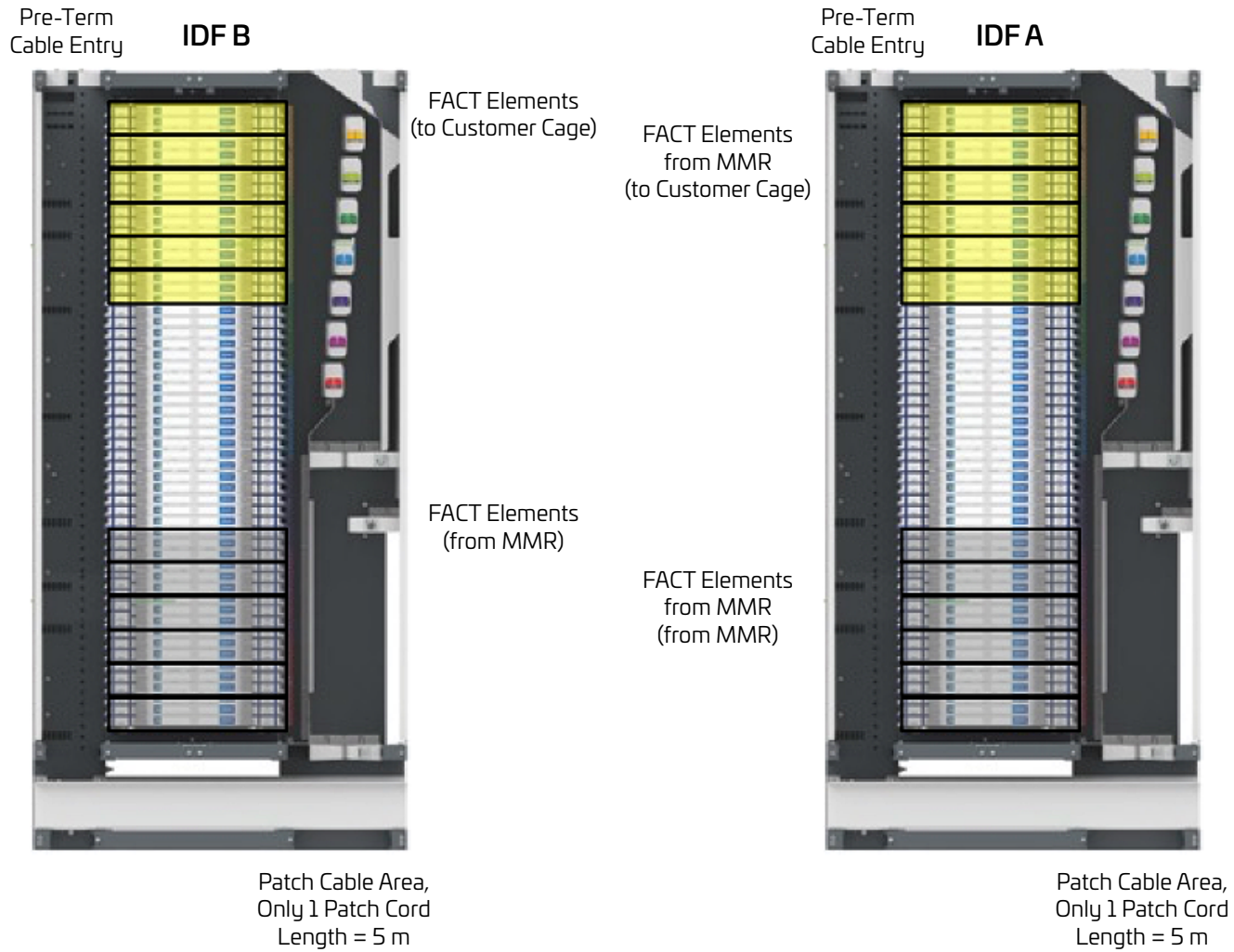

Direct System Selection Index

Splice Closures	Building Entrance Solutions	FACT Optical Distribution Frame	Propel XFrame	19" Splice Solutions	Singlemode Fiber Cables	Pre-term 19" Fiber	Pre-term FACT ODF Fiber	Fiber Optic Patch Cords	FiberGuide	Copper Category 6A	Cable Management & Overhead Racks	FiberREACH
-----------------	-----------------------------	---------------------------------	---------------	----------------------	-------------------------	--------------------	-------------------------	-------------------------	------------	--------------------	-----------------------------------	------------

Architecture System Selection Index

Colocation Campus and Building Infrastructure

Fiber Entrance, Meet-Me Room	High Fiber Count DC Interconnect	Campus Cabling	Building Cabling	Campus Cabling for Wi-Fi and Security
------------------------------	----------------------------------	----------------	------------------	---------------------------------------

Customer Space Cabling Infrastructure

XC Fiber	ToR Fiber	EoR Copper	FiberGuide Raceway
----------	-----------	------------	--------------------

Reference Designs and Technical Information

MDA Cabinet	MDA Cross-connect 19"	MDA Cross-connect FACT ODF	IDF FACT	IDF 19"
-------------	-----------------------	----------------------------	----------	---------



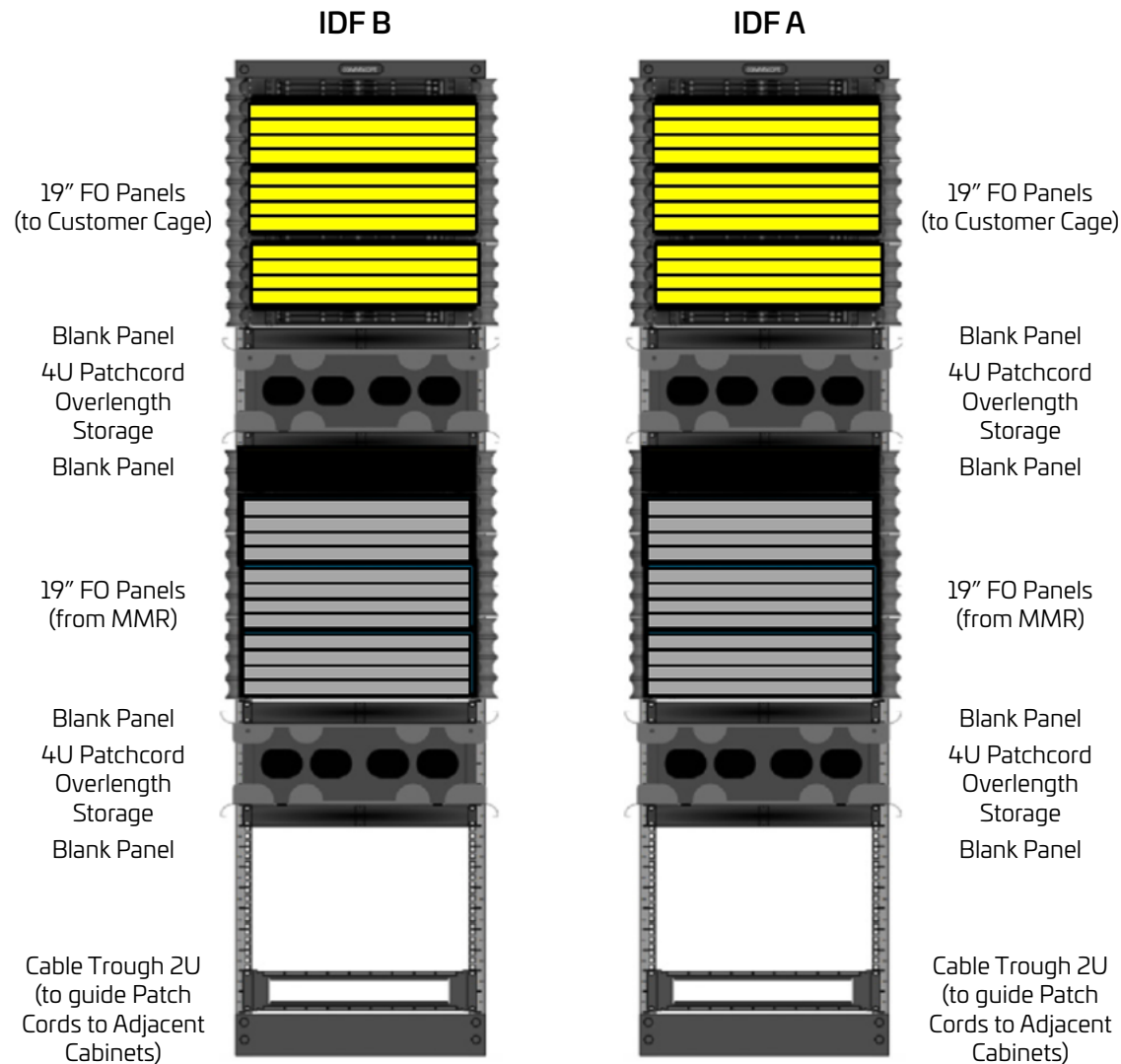
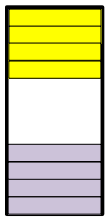

Direct System Selection Index

Splice Closures	Building Entrance Solutions	FACT Optical Distribution Frame	Propel XFrame	19" Splice Solutions	Singlemode Fiber Cables	Pre-term 19" Fiber	Pre-term FACT ODF Fiber	Fiber Optic Patch Cords	FiberGuide	Copper Category 6A	Cable Management & Overhead Racks	FiberREACH
-----------------	-----------------------------	---------------------------------	---------------	----------------------	-------------------------	--------------------	-------------------------	-------------------------	------------	--------------------	-----------------------------------	------------

Architecture System Selection Index

Colocation Campus and Building Infrastructure

Fiber Entrance, Meet-Me Room	High Fiber Count DC Interconnect	Campus Cabling	Building Cabling	Campus Cabling for Wi-Fi and Security
------------------------------	----------------------------------	----------------	------------------	---------------------------------------

Customer Space Cabling Infrastructure

XC Fiber	ToR Fiber	EoR Copper	FiberGuide Raceway
----------	-----------	------------	--------------------

Reference Designs and Technical Information

MDA Cabinet	MDA Cross-connect 19"	MDA Cross-connect FACT ODF	IDF FACT	IDF 19"
-------------	-----------------------	----------------------------	----------	---------



CommScope pushes the boundaries of communications technology with game-changing ideas and ground-breaking discoveries that spark profound human achievement. We collaborate with our customers and partners to design, create and build the world's most advanced networks. It is our passion and commitment to identify the next opportunity and realize a better tomorrow. Discover more at commscope.com.



commscope.com

Visit our website or contact your local CommScope representative for more information.

©2026 CommScope Technologies LLC, an Amphenol company. All rights reserved. CommScope and the CommScope logo are registered trademarks of CommScope and/or its affiliates in the U.S. and other countries. For additional trademark information see <https://www.commscope.com/trademarks>. All product names, trademarks and registered trademarks are property of their respective owners.

CO-120395.2-EN (06/26)

